

User's Manual FWP6 Probe Station Operating Guide

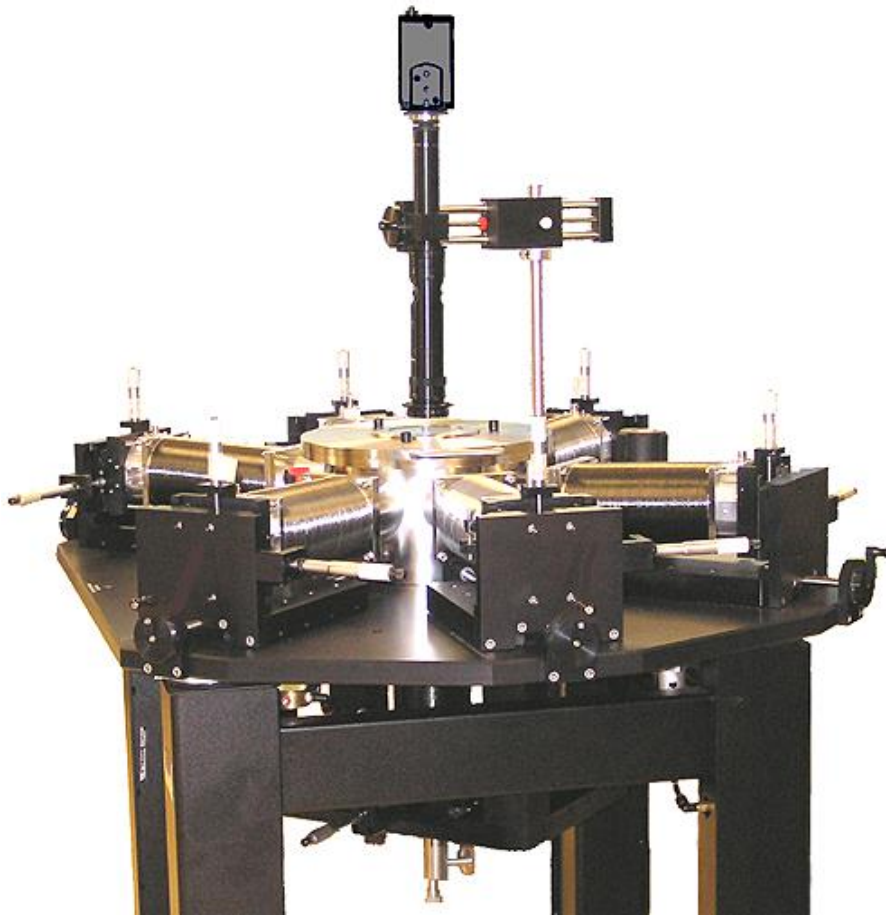

Lake Shore Cryotronics, Inc,
575 McCorkle Blvd.
Westerville, OH 43082
Phone: 614-891-2243
Fax: 614-818-1600
sales@lakeshore.com
service@lakeshore.com
www.lakeshore.com

LIMITED WARRANTY STATEMENT

WARRANTY PERIOD: THREE (3) YEARS

1. Lake Shore warrants that products manufactured by Lake Shore (the "Product") will be free from defects in materials and workmanship for three years from the date of Purchaser's physical receipt of the Product (the "Warranty Period"). If Lake Shore receives notice of any such defects during the Warranty Period and the defective Product is shipped freight prepaid back to Lake Shore, Lake Shore will, at its option, either repair or replace the Product (if it is so defective) without charge for parts, service labor or associated customary return shipping cost to the Purchaser. Replacement for the Product may be by either new or equivalent in performance to new. Replacement or repaired parts, or a replaced Product, will be warranted for only the unexpired portion of the original warranty or 90 days (whichever is greater).
2. Lake Shore warrants the Product only if the Product has been sold by an authorized Lake Shore employee, sales representative, dealer or an authorized Lake Shore original equipment manufacturer (OEM).
3. The Product may contain remanufactured parts equivalent to new in performance or may have been subject to incidental use when it is originally sold to the Purchaser.
4. The Warranty Period begins on the date the Product ships from Lake Shore's plant.
5. This limited warranty does not apply to defects in the Product resulting from (a) improper or inadequate installation (unless OT&V services are performed by Lake Shore), maintenance, repair or calibration, (b) fuses, software, power surges, lightning and non-rechargeable batteries, (c) software, interfacing, parts or other supplies not furnished by Lake Shore, (d) unauthorized modification or misuse, (e) operation outside of the published specifications, (f) improper site preparation or site maintenance (g) natural disasters such as flood, fire, wind, or earthquake, or (h) damage during shipment other than original shipment to you if shipped through a Lake Shore carrier.
6. This limited warranty does not cover: (a) regularly scheduled or ordinary and expected recalibrations of the Product; (b) accessories to the Product (such as probe tips and cables, holders, wire, grease, varnish, feed throughs, etc.); (c) consumables used in conjunction with the Product (such as probe tips and cables, probe holders, sample tails, rods and holders, ceramic putty for mounting samples, Hall sample cards, Hall sample enclosures, etc.); or, (d) non-Lake Shore branded Products that are integrated with the Product.
7. To the extent allowed by applicable law, this limited warranty is the only warranty applicable to the Product and replaces all other warranties or conditions, express or implied, including, but not limited to, the implied warranties or conditions of merchantability and fitness for a particular purpose. Specifically, except as provided herein, Lake Shore undertakes no responsibility that the products will be fit for any particular purpose for which you may be buying the Products. Any implied warranty is limited in duration to the warranty period.
8. Further, with regard to the United Nations Convention on International Sale of Goods (CISG,) if CISG is found to apply in relation to this agreement, which is specifically disclaimed by Lake Shore, then this limited warranty excludes warranties that: (a) the Product is fit for the purpose for which goods of the same description would ordinarily be used, (b) the Product is fit for any particular purpose expressly or impliedly made known to Lake Shore at the time of the conclusion of the contract. (c) the Product is contained or packaged in a manner usual for such goods or in a manner adequate to preserve and protect such goods where it is shipped by someone other than a carrier hired by Lake Shore.
9. Lake Shore disclaims any warranties of technological value or of non-infringement with respect to the Product and Lake Shore shall have no duty to defend, indemnify, or hold harmless you from and against any or all damages or costs incurred by you arising from the infringement of patents or trademarks or violation or copyrights by the Product.
10. THIS WARRANTY IS NOT TRANSFERRABLE. This warranty is not transferrable.
11. Except to the extent prohibited by applicable law, neither Lake Shore nor any of its subsidiaries, affiliates or suppliers will be held liable for direct, special, incidental, consequential or other damages (including lost profit, lost data, or downtime costs) arising out of the use, inability to use or result of use of the product, whether based in warranty, contract, tort or other legal theory, regardless whether or not Lake Shore has been advised of the possibility of such damages. Purchaser's use of the Product is entirely at Purchaser's risk. Some countries, states and provinces do not allow the exclusion of liability for incidental or consequential damages, so the above limitation may not apply to you.
12. This limited warranty gives you specific legal rights, and you may also have other rights that vary within or between jurisdictions where the product is purchased and/or used. Some jurisdictions do not allow limitation in certain warranties, and so the above limitations or exclusions of some warranties stated above may not apply to you.
13. Except to the extent allowed by applicable law, the terms of this limited warranty statement do not exclude, restrict or modify the mandatory statutory rights applicable to the sale of the product to you.

Copyright 2015 Lake Shore Cryotronics, Inc. All rights reserved. No portion of this manual may be reproduced, stored in a retrieval system, or transmitted, in any form or by any means, electronic, mechanical, photocopying, recording, or otherwise, without the express written permission of Lake Shore.

Table of Contents

Precautions and Safety Considerations	5
Technical Inquiries	6
Return of Equipment	6
1. How It Works	7
1.1 The Probe Station.....	8
1.2 Signal Connections.....	11
1.3 The Transfer Line	12
1.4 Temperature Control	13
2. Assembly.....	16
2.1 Required Tools	16
2.2 Unpacking	16
2.2.1 The Probe Station and Stand.....	16
2.2.2 Vision System	18
2.2.3 Transfer Line.....	18
2.2.4 Temperature Controller.....	19
2.2.5 Turbo Vacuum System	19
2.2.6 Tools, O-Rings, and Hardware	19
2.3 Assemble the Turbo Vacuum System	19
2.4 Assemble the Vision System	23
2.5 Install Probes.....	26
2.5.1 Open the Chamber	26
2.5.2 Remove the Sample Holder	27
2.5.3 Install a Probe	27
2.5.3.1 Installing a ZN50 Probe.....	28
2.5.3.2 Installing a Microwave Probe	29
2.5.3.3 Installing a Fiber Optic Probe	29
2.5.3.4 Attaching the Braid Block	30
2.6 Attach Cables	30
2.6.1 Temperature Controller Cables.....	30
2.6.2 Radiation Shield Heater	32
2.6.3 Signal Connections	35
2.7 220 V Operation	36
3. Operation.....	37
3.1 Required Tools	37
3.2 Select a Probe Type	37
3.3 Load a Sample	37
3.4 Seal the Chamber.....	39
3.5 Evacuate the Chamber	39
3.6 Cool the Sample	40
3.7 View the Sample.....	42
3.8 Make Contact	42
3.9 Make Measurements	43
3.10 Return to Room Temperature.....	43
3.11 Unload the Sample	44
3.12 Heating the Sample	44
4. Configuration Changes	45

4.1	Changing Probe Arms	45
4.1.1	Removing a Probe Arm Assembly	45
4.1.2	Installing a Probe Arm Assembly	48
4.2	Changing Cables	50
4.2.1	Removing Cables	50
4.2.2	Installing Cables.....	50
4.2.2.1	Installing a Miniature Coax Cable	51
4.2.2.2	Installing a Semi-Rigid Cable.....	51
4.2.2.3	Installing a Fiber Optic Cable.....	52
4.3	Adjusting the Fit of Semi-Rigid High Frequency Cables	53
5.	Optional Equipment.....	54
5.1	Probes	54
5.1.1	High-Impedance Measurement Description	54
5.1.2	Planarization Assembly	54
5.1.2.1	Installing the Planarization Assembly	54
5.1.2.2	Using the Planarization Assembly.....	56
5.2	Sample Holders.....	56
5.3	Vibration Isolation Equipment.....	57
5.3.1	Pump Line Vibration Isolator	57
5.4	Chamber Vacuum Level Gauge	57
6.	Maintenance	58
6.1	Cleaning Probe Tips.....	58
6.2	Applying Anti-Fog to the Chamber Viewport.....	59
6.3	Replacing Probe Blades	59
6.4	Transfer Line and Cryogenic Efficiency	61
7.	Troubleshooting	62
7.1	The Microscope Will Not Focus.....	62
7.2	The System Fails to Cool	62
7.3	Loss of Continuity between the Signal Connector and the Blade	62
7.4	Insufficient Sample Illumination	62
Appendix 1. Temperature Control Connection and Electrical Pinouts....		63
Appendix 2. Low Current Measurements and Triax Configuration		65

Precautions and Safety Considerations

Please read this manual before operating the system.

Your Desert Cryogenics system has been engineered to provide safe and dependable operation when properly used. Proper safety considerations must be observed. Please read the system manuals and particularly the following list of warnings before operation. Do not operate the system before becoming familiar with recommended procedures. Please see also the manuals for the included components for general precautions and handling procedures.



Before evacuation or release of vacuum, ensure probe tips are raised off the sample by a minimum of 2.5 mm.



The range of the stages in some axes exceeds the range of movement accommodated by the system without interference. When moving near any extreme, take precautions to ensure that no interference with a probe arm will occur.



Cold parts: Cooled components remain cold for some time after the refrigeration has stopped. Handling cryogenically cooled components can cause severe cold burns. Handling the cold ends of the transfer line can cause severe cold burns. The use of gloves when removing the transfer line is recommended. Before venting the system and handling parts that have been cooled, verify they are at room temperature. This also prevents water condensation on samples and system components.



Cold helium and nitrogen: Liquid cryogenics are extremely cold and can cause severe cold burns especially when flowing rapidly as they can from the end of the transfer line. Observe proper precautions when handling cryogenics.



High pressures: Gas which is cryogenically cooled and/or liquefied can cause explosively high pressure in the refrigerator or vacuum space when the system is brought back to room temperature. Pressure relief valves are designed to prevent a build-up of pressure. Never alter, restrain, or remove any pressure relief valve.



Handling the transfer line: The transfer line flex section must never be bent to less than an 8-inch (203 mm) radius. Tighter bends can damage the transfer line. Take care not to bend the straight tubes at the ends of the transfer line. The supply-Dewar end of the transfer line incorporates a metering valve (the 'foot valve'), which regulates the flow of cryogen through the system. Please do not over-tighten this valve.



Control: Never input setpoints into the temperature controller that are outside the range of operation of the system. The heater should not be operated unless the vacuum space is under vacuum. The heater should not be operated with zero flow through the refrigerator. Some flow is needed to provide stable control and to prevent rapid overheating.

Technical Inquiries

Technical inquiries the user may have concerning the installation, operation, or maintenance requirements of this equipment should be directed to Service at Lake Shore (see the contact information below).

Return of Equipment

Before returning equipment, please contact Lake Shore Service for instructions:

Lake Shore Cryotronics, Inc.
575 McCorkle Blvd.
Westerville, Ohio 43082 USA
Phone: 614-891-2243
Fax: 614-818-1600
e-mail: service@lakeshore.com

For each item being returned, including the equipment name, model number, and serial number will aid in assuring prompt response. The model and serial numbers are listed in a separate document provided with the system.

You will be given an RMA (Return Materials Authorization) number. This number is necessary for all returned equipment. It must be clearly indicated on both the shipping carton(s) and any correspondence relating to the shipment.

NOTE: the user should retain the shipping carton(s) in which equipment is originally received, for convenience in case any equipment has to be returned.

RMA Valid Period

It is suggested that equipment to be repaired be shipped to Lake Shore within 30 days after the RMA has been issued. Equipment returned later than 30 days after the warranty expiration date will be subject to repair charges irrespective of the RMA issuance date.

Shipping Charges

All shipments to factory are to be made prepaid. Equipment serviced under warranty will be returned shipping prepaid. Equipment serviced out-of-warranty will be returned FOB factory.

Concealed Shipping Damage

The instrument is packaged to protect it during shipment. Please use reasonable care when removing it from its protective packaging and inspect the instrument carefully for damage. If it shows any sign of damage, please file a claim with the carrier immediately. Do not destroy the shipping container; it will be required by the carrier as evidence to support claims. Call Lake Shore for return and repair instructions.

Restocking Fee

Lake Shore reserves the right to charge a 15% restocking fee for items returned for exchange or reimbursement.

1. How It Works

The FWP6 Probe Station is a cryogenic manipulated-probe testing station used for non-destructive electrical testing of devices on full and partial wafers up to 4 inches in diameter. Cryogenic operation is based on a continuous-transfer cryogenic refrigerator designed by Desert Cryogenics specifically for the probe station. These systems are versatile and state-of-the-art, providing temperatures from 4.2 K to 475 K. The system is designed to be safe, easy to use, and easily computer controlled.

There are five major components to the system:

1. The probe station, with up to eight independently manipulated probe arms, each holding a DC, microwave, or other probe.
2. An optical system (microscope, camera, light source, and monitor) to view the sample under test.
3. A turbo vacuum system to evacuate the probe station.
4. A transfer line to carry the cryogen (liquid helium or liquid nitrogen) from a Dewar to the refrigerator in the probe station.
5. A temperature controller to regulate the sample temperature.

The system is illustrated below. The photo shows the probe station with the microscope and camera installed. The remaining components necessary to run the system are shown connected to the probe station. To use the system, samples are placed inside the probe station chamber, the system is evacuated with the turbo vacuum system, and the sample is cooled with a cryogen. Probes are moved into place on the sample while observing with the microscope. Measurements of sample properties are then made via the probes.

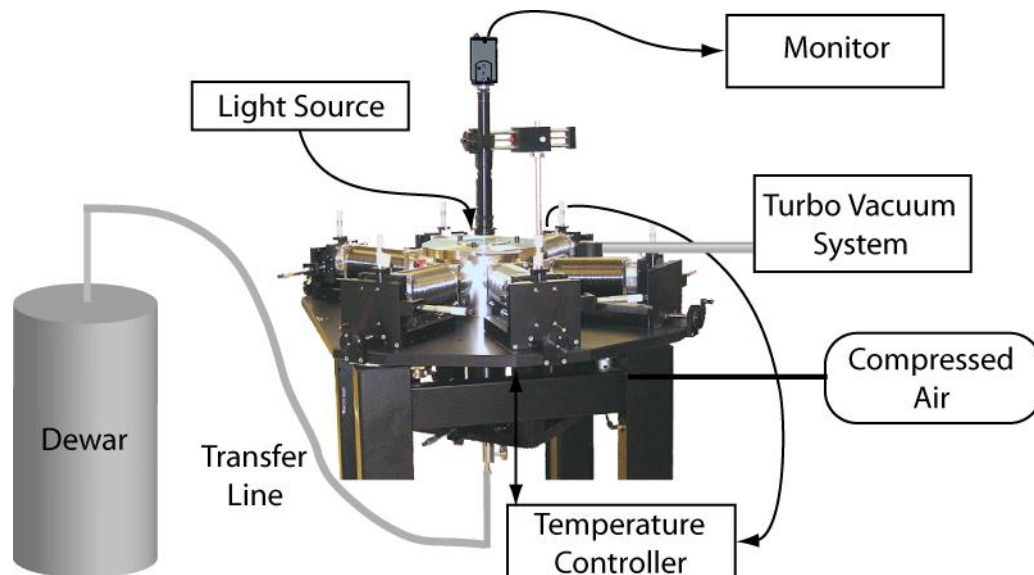

Manuals for the monitor, turbo vacuum system, light source, temperature controller, and vibration isolation stand are provided with the system. Documentation for the microscope can be obtained from the Thales Optem web site, <http://www.thales-optem.com>. It is assumed that the user is familiar with the handling of cryogenics and Dewars.

1.1 The Probe Station

The primary components of the probe station are a sealed chamber and bellows to achieve a vacuum, a refrigerator, and up to eight stages, each with a probe arm and probe. The probe arms are inside the bellows. A more detailed picture and description of the probe station and microscope system are below.

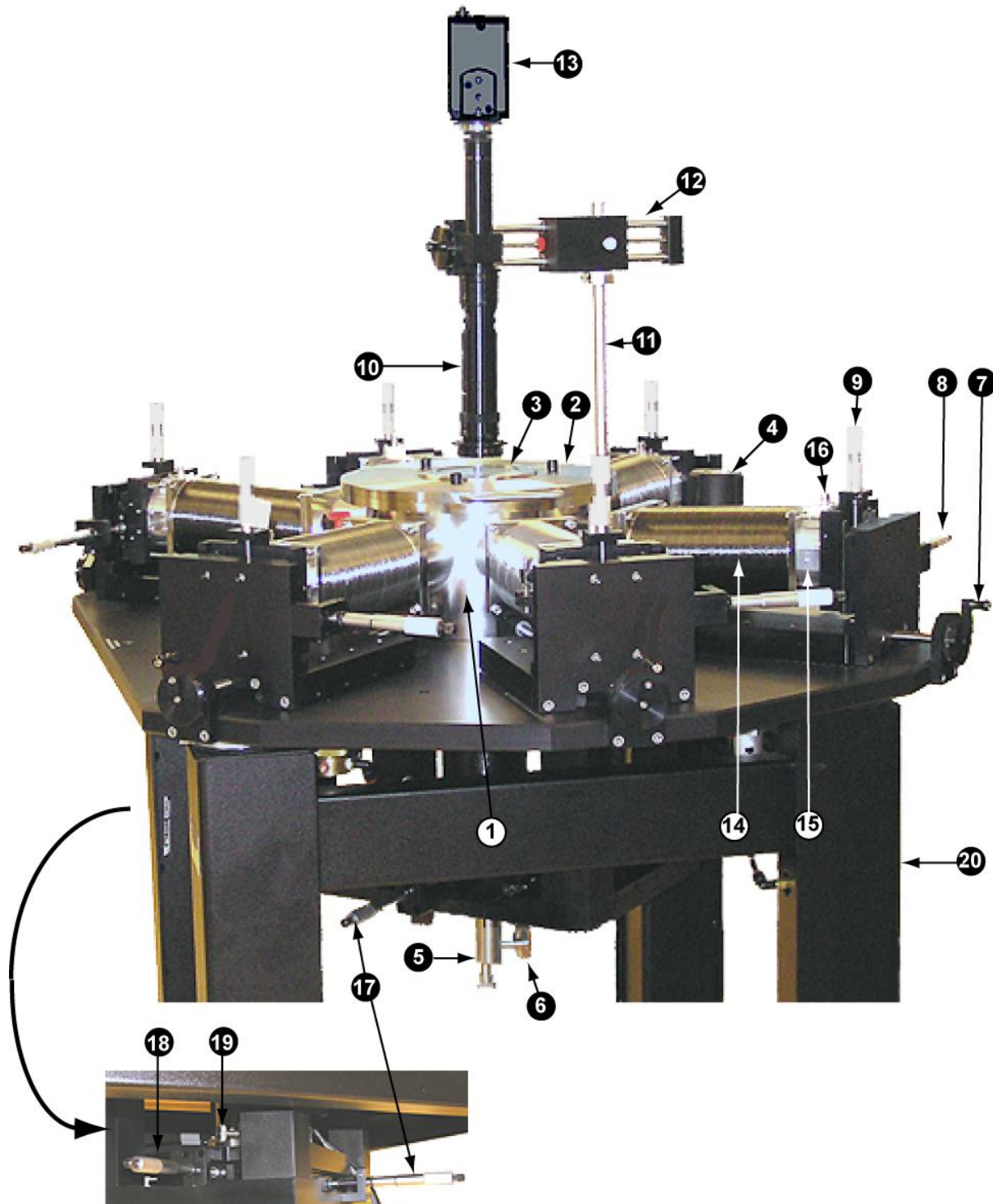

- 1 **Chamber** – The chamber contains the sample. The chamber and bellows (14) are under vacuum once the turbo vacuum system is turned on. The internal components of the chamber are described below.
- 2 **Chamber Lid** – Seals the chamber.
- 3 **Chamber Lid Viewport** – Allows viewing of the sample either directly or with the microscope and CCD camera.
- 4 **Vacuum Isolation Valve** – Opens and closes the connection between the probe station and the turbo vacuum system. The turbo vacuum system connects to the probe station through the NW25 connector on the valve. The vacuum system evacuates the chamber and the areas internal to the bellows. Next to the vacuum isolation valve is a pressure relief valve (not visible in the photo), which relieves excessive pressure.
- 5 **Bayonet** – Cryogen inlet and exhaust tube. The cryogen is routed from the Dewar to the probe station via the transfer line. The transfer line is inserted into the bayonet. The bayonet is also shown in the diagram below.
- 6 **NW16 Exhaust Port** – Cryogen exits the probe station through this port. The exhaust can be recaptured or vented away from the equipment. An optional vacuum pump can be attached to the NW16 connector to cool the system to 3 K.
- 7 **X-Axis Hand Dial** – Controls the in-out movement of the probe. After achieving the desired temperature, the probes are manipulated into place using the X-, Y-, and Z-axis controllers for each probe. The control is also shown in the diagram below.
- 8 **Y-Axis Micrometer** – Controls the left-right movement of the probe. Also shown below.
- 9 **Z-Axis Micrometer** – Controls the probe height relative to the sample. Also shown below.
- 10 **Microscope** – Used to view the sample. The microscope can be moved to view any portion of a 2-inch wafer under the window. The standard microscope is an Optem Zoom 70XL with 7:1 zoom range and 5 μ m resolution. Optional microscopes are the Optem 125, with 12.5:1 zoom range and 2 μ m resolution, and the Optem 160, with 16:1 zoom range and 1.5 μ m resolution.
- 11 **Microscope Vertical Post** – Supports the microscope.
- 12 **Microscope Translator** – Allows the microscope to be moved into position over the sample.
- 13 **CCD Camera** – Collects images from the microscope.
- 14 **Bellows** – The bellows are flexible stainless steel.
- 15 **Feedthrough Housing** – Provides the interface between ambient pressure and the internal vacuum. Signal inputs and outputs are passed to the sample through the feedthrough housing. The feedthrough housing is also shown in the diagram below.
- 16 **Signal Connector** – Input signals to the sample and read outputs through the signal connector. The connector is also shown in the diagram below.
- 17, 18 **Sample Micrometers** – Move the sample in the XY plane relative to the probes, allowing all probes to access any position on a 4-inch sample. These controls are also shown in the diagram below.
- 19 **Theta Adjustment Knob** – Controls the rotation of the sample relative to the probes. The range of motion is $\pm 5^\circ$. This control is also shown in the diagram below.
- 20 **Stand** – Supports the probe station with pneumatic legs that provide vibration isolation.

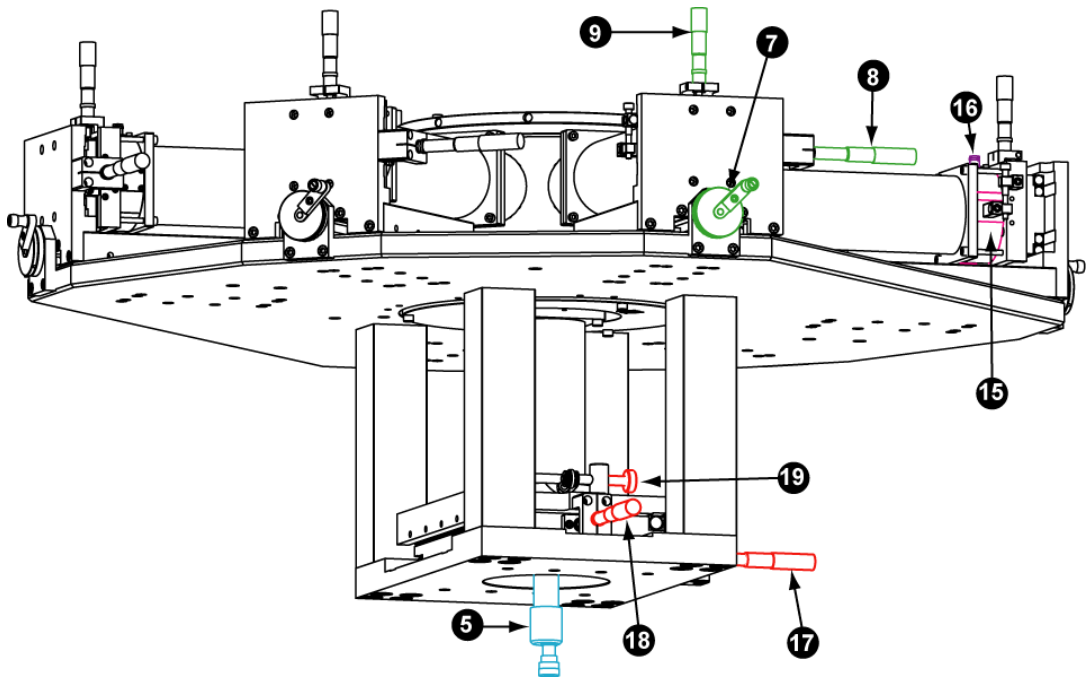

A detailed diagram of the interior of the chamber is shown below. **Note:** the numbering is different from the previous diagrams.

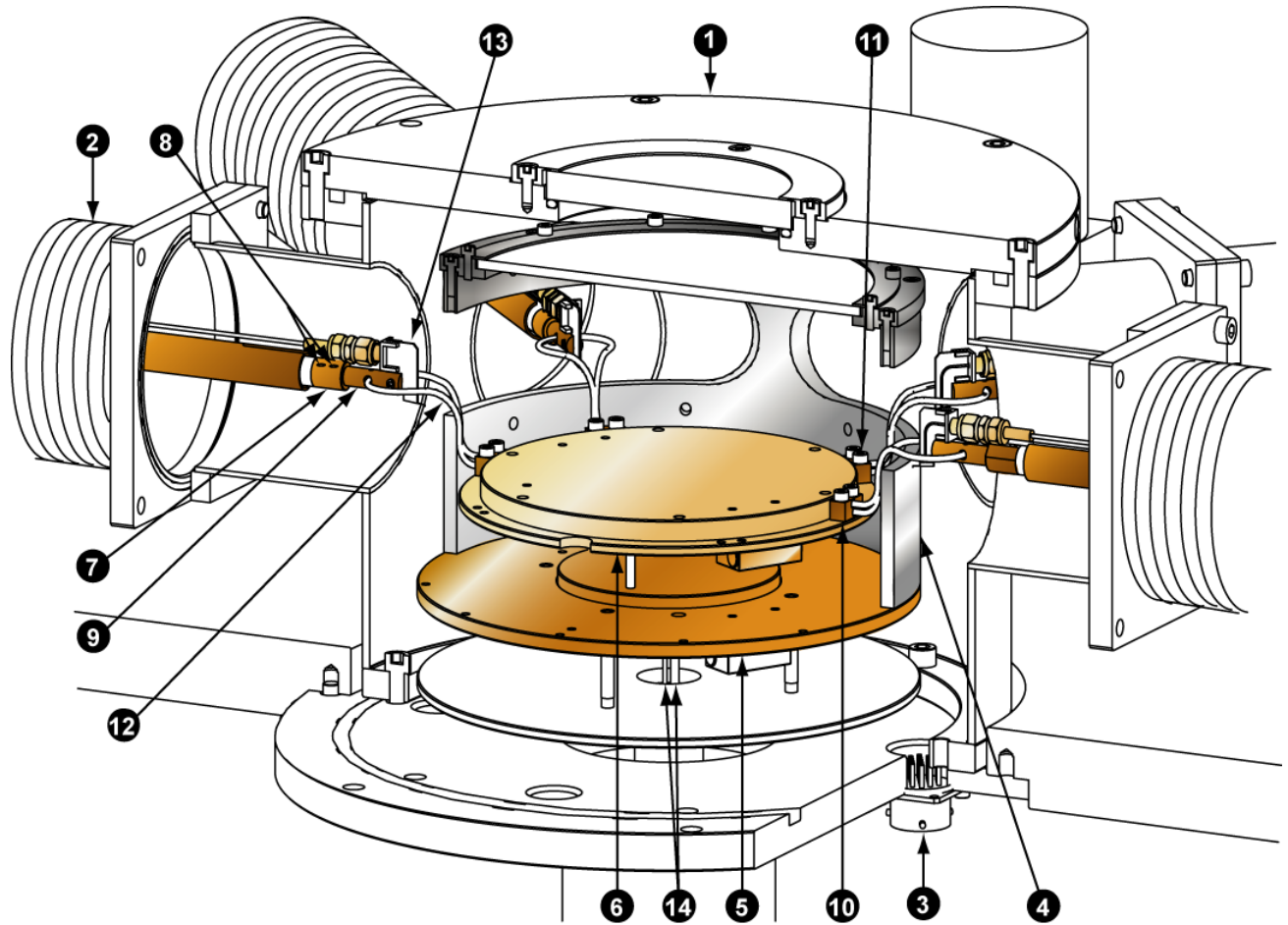

- ① **Chamber** – Also called the vacuum chamber. The chamber and bellows (②) are under vacuum once the turbo vacuum system is turned on.
- ② **Bellows** – Provide structural support around the probe arms when the system is under vacuum. The flexible stainless steel bellows allow manipulation of the probes while maintaining system vacuum.
- ③ **Temperature Controller Feedthrough** – The 19-pin interface connects the temperature controller to the probe station.
- ④ **Radiation Shield** – Provides thermal radiation shielding. The body is aluminum.
- ⑤ **Radiation Shield Base** – The copper base of the radiation shield.
- ⑥ **Cold Head** – Cools the sample. The sample is attached to the sample holder (not shown), which is screwed to the cold head. Cryogen is routed through the cold head. The temperature of the cold head is regulated through a temperature sensor and heater. The temperature sensor is screwed to the underside of the cold head. The heaters consist of two cartridge heaters wired in parallel and screwed to the bottom of the cold head. The temperature sensor output and heater inputs are connected to the temperature controller via the temperature controller feedthrough (③).
- ⑦ **Probe Arm** – The probe arms enter the radiation shield (④) from the sides. One of the probe arms has an embedded temperature sensor in the approximate location indicated by the arrow. A connector to read the sensor is on the side of the stage.
- ⑧ **Probe Set Screws** – Attach the probe (⑨) to the probe arm (⑦). The screws are M3.
- ⑨ **Probe Body** – The probe shown is the standard ZN50 model. The probe body supports the probe blade (⑬), which conducts signals between the sample and the probe arm cable. The probe body is copper.
- ⑩ **Braid Block** – The copper braid block thermally anchors the probe (⑨) to the cold head (⑥) so that the probe temperature is near the sample temperature.
- ⑪ **Braid Block Screws** – Attach the braid block to the cold head (⑥). The screws are M3 × 10.
- ⑫ **Probe Braid** – Provides the thermal connection between the cold head (⑥) and the probe body (⑨). The braids are copper.
- ⑬ **Probe Blade** – Provides the electrical contact to the sample. Signals from external equipment travel through the bellows and connect to the alumina probe blade. A silver strip line on one side of the blade conducts signals to the sample. The other side of the blade is a ground plane (coax connections) or a guard plane (triax connections) to reduce electrical noise. Avoid touching the blade with bare hands as this can reduce its electrical isolation to ground.
- ⑭ **Cryogen Inlet and Outlet** – Cryogen enters the chamber through the small tube and exits through the larger tube.

Cryogen enters the probe station through the bayonet. From there it is routed through the bottom of the chamber, then into the radiation shield where it cools the cold head and the radiation shield base. The cryogen then leaves the radiation shield and bottom of the chamber and is exhausted through the NW16 exhaust port on the bayonet.

1.2 Signal Connections

The diagram below illustrates how external equipment is connected to the sample. A standard ZN50 probe and probe arm are shown, but other probe types use similar routing.

Signals for testing samples and reading sample responses are routed between the signal connector and the sample via the probe arm and probe. This route is illustrated by the blue path in the diagram.

The optional coax and triax sample holders allow the user to apply ground or bias voltages to the sample holder. These signals are routed from the bottom of the chamber to the sample holder, as shown by the red path. (The wire from the connector to the sample holder is actually wrapped around one of the cold head support legs. It is drawn as shown to schematically illustrate the connection.)

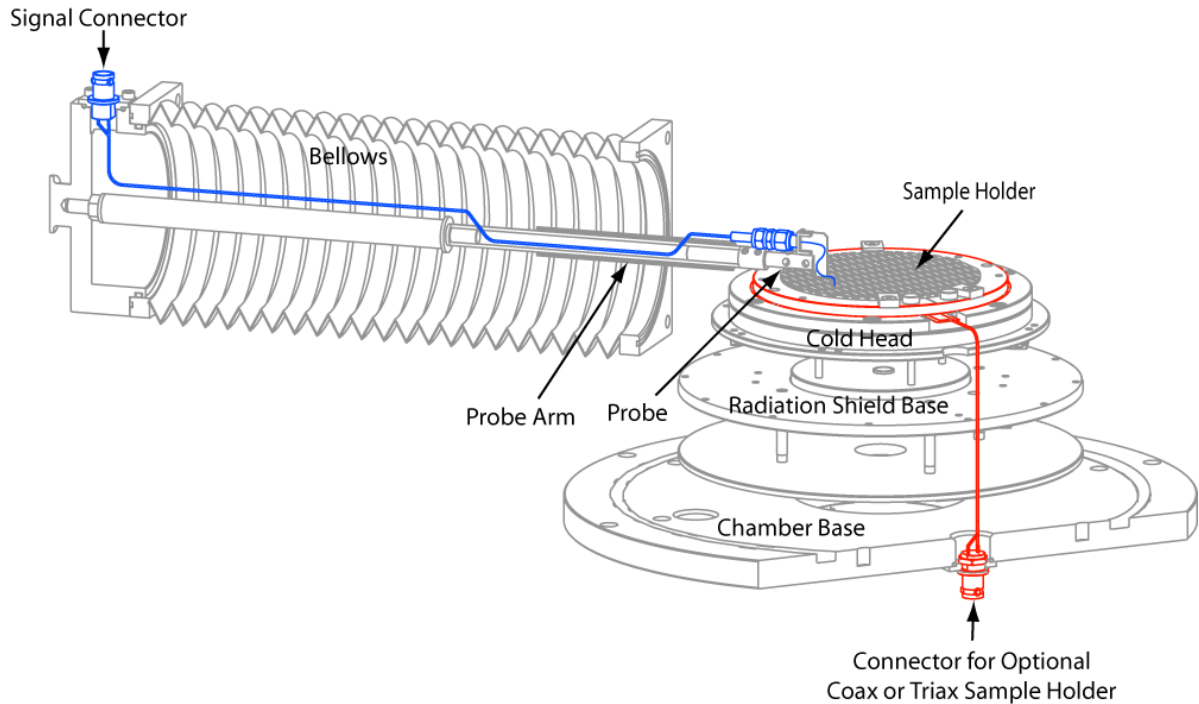

1.3 The Transfer Line

The transfer line routes cryogen from the Dewar to the probe station.

The end that inserts into the cryogen Dewar (the supply-side leg) is 0.5-inch (12.7 mm) diameter and incorporates a foot valve. This valve is used to regulate the flow through the transfer line. The inlet at the bottom of the supply-side leg incorporates a filter, which prevents ice from plugging the transfer line. Because of this filter, the transfer line can be inserted fully to the bottom of the Dewar. The end that inserts into the probe station bayonet (the target-side leg) is 0.25-inch (6.35 mm) diameter. Between the transfer line legs is a flexible section. This allows the transfer line to be manipulated into the probe station after the supply-side leg has been inserted in the Dewar.

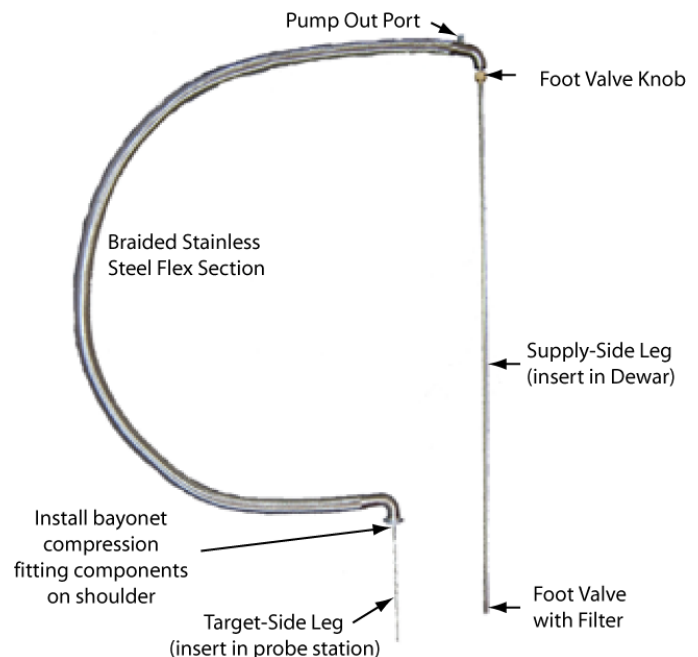

Between the foot valve knob and the flex section is a pump-out port. This port is used to pump the transfer line, and may be used to leak-check and re-evacuate the line. A valve actuator (included with the system) is required for this operation.

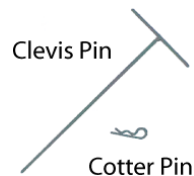

The clevis pin and cotter pin are used to secure the transfer line to the probe station.

1.4 Temperature Control

The temperature controller provides a stable temperature for measurements at any temperature within the range of the probe station. The controller senses the system temperature and sends DC heater power to the probe station heater as required, balancing the amount of heater power against the cooling power available at the cold head to provide a stable temperature at any set point entered by the user. The controller also balances its time response against that of the probe station in order to achieve a stable temperature without oscillations or unnecessary delays.

The system has three temperature sensors, located in the cold head, probe arm end, and radiation shield base. The system also has two heaters, located on the radiation shield base and cold head. The sensor and heater locations are shown below.

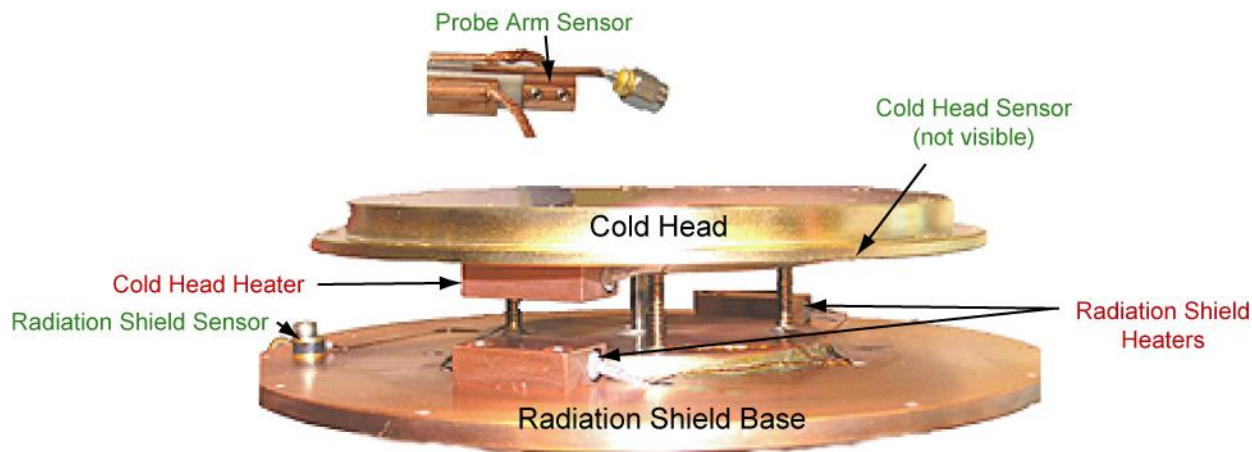

If the heaters are not on, then, once a large volume of liquid helium is flowing through the system, the temperature of the cold head will drop to 4.5 K or less. Typical plots for cooldown from room temperature to 4.5 K are shown below, although your system may vary by five or more minutes from these plots. The RS-232 or GPIB ports on the temperature controller can be used to obtain plots such as these. Note that the probe arm sensor curve does not go below 28 K – below that the controller output does not represent the true probe arm temperature. Tests with other thermometers show that the probe arm temperature does in fact continue to drop and approaches the temperature of the cold head.

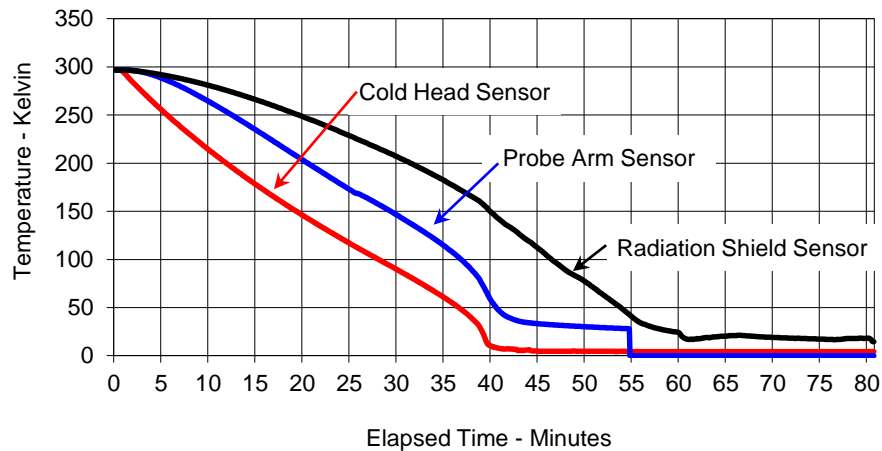

Sample temperatures above 4.2 K are achieved by reducing the flow of helium using the foot valve on the transfer line, reducing the Dewar pressure, and programming the temperature controller to a higher set point. The flow of helium should be reduced to bring the sample to slightly below the desired temperature, and the temperature controller set to the actual desired temperature. The amount of helium required, i.e., the amount to close foot valve for a given temperature, is learned with practice.

The standard temperature controller can control two loops.

- Loop 1 uses the cold head sensor and heater. The temperature controller receives the sensor input and sends a voltage to control the heater element in the cold head.
- Loop 2 uses the radiation shield sensor and heater. The temperature controller receives the sensor output. Because the temperature controller can heat only one element (generally the cold head), it sends a signal to an auxiliary power supply, which sends a control voltage to the radiation shield heater.

With three sensors and two heaters, two basic configurations are possible: operate both loops simultaneously without sensing the probe arm temperature, or operate one loop and sense the probe arm or radiation shield temperature.

The following diagram illustrates the case when both loops are active. This configuration is normally used when bringing the system to room temperature, but can also be used to control the sample environment more precisely. The probe arm sensor is disconnected when both loops are active.

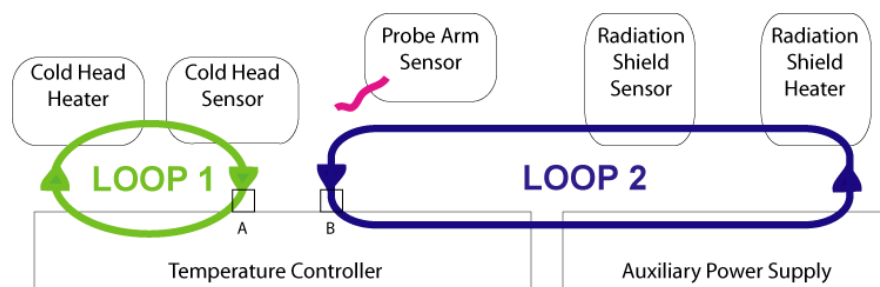

The probe arm sensor is used to monitor the probe temperature, and is not used for a control loop unless an optional probe arm heater is installed. To monitor the probe arm temperature, the radiation shield sensor is disconnected from the back of the temperature controller and replaced with the probe arm sensor. This configuration is illustrated below. It can be used to maintain the sample at a given temperature while monitoring the cold head and probe arm temperatures. **Note:** the radiation shield loop *must* be turned off in the temperature controller or the radiation shield heater will not be controlled properly and a ‘runaway heater’ condition can occur.

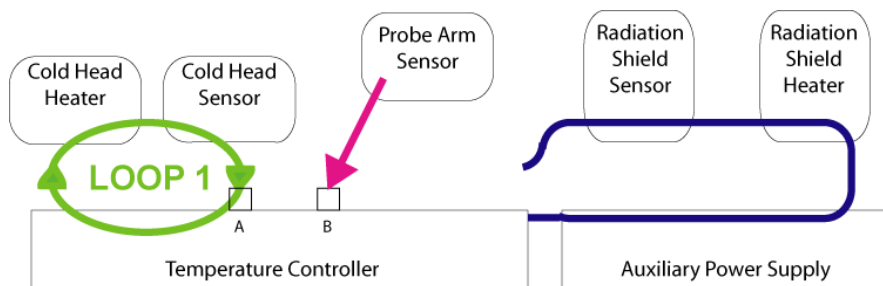

The types of sensors and heaters are listed below. This data is used to program the temperature controller when various sensors are connected to it.

Sensors:

Location	Temperature Controller Channel	Type	Calibration/Controller Curve
Cold Head	A	Silicon Diode	Calibrated DT-670/Curve 21*
Probe Arm End	B	100 Ω Plat/250	Uncalibrated/standard PT-100
Radiation Shield Base	B	Silicon Diode	Uncalibrated/standard DT-670

* Curve 21 is programmed at the factory to match your cold head thermometer. The serial number of the sensor should match the number displayed by the temperature controller when curve 21 is selected.

Heaters:

Location	Powered By	Control Channel	Resistance	Power
Cold Head	Lake Shore	A-Loop1	50 Ω	50 W at 50 V max
Radiation Shield Base	Protek Auxiliary Power Supply	B-Loop2	25 Ω	100 W at 50 V max

Details of the cable connections are described in the Assembly section. More information on operating the temperature controller is in the temperature controller manual.

2. Assembly

A ship list is included with the system. Consult the list during unpacking and assembly to help identify the parts.

2.1 Required Tools



Hex keys or drivers
3/16, 5/64, 0.05 inch,
several metric keys
(keys are supplied with the toolkit)



Wirecutters



Screwdriver
(an electric screwdriver is
preferable for unpacking)



Tweezers

A ratchet or wrench is also required for unpacking.

2.2 Unpacking

On receipt of the system, check for signs of rough handling as might be indicated by damage to the shipping container(s) or by indicators attached to the outside and inside of the shipping container(s). If any physical damage is suspected, please inform the shipping agents and Service at Lake Shore immediately. Please report any potential shortages or damage as soon as possible after discovery.

Before unpacking, prepare a clean area in which to put the probe system and transfer line as well as any additional or optional components. Shipping containers and shipping fixtures should be kept.

2.2.1 The Probe Station and Stand

Unpack the stand first so there is a place to set the probe station. The stand and probe station will be very difficult to move after assembly, so place the stand in its permanent location.

Because the stand is pneumatic, the probe station should be placed with a particular orientation on the stand. Therefore, the orientation of the stand is important. Three of the stand legs have height control valves, while the fourth is slaved to another. The slave leg can be identified by its filter. The three ‘effective’ support points are the point midway between the slave and its master and the two support points of the other legs. Connecting these points forms a load triangle. The center of gravity of the probe station should be placed within this triangle.

The center of gravity of the station is influenced by the number of stages, the microscope, and the monitor (if the monitor is clamped to the station). The microscope will be mounted towards the rear of the station compared to the Desert Cryogenics logo. The monitor can be clamped to any convenient side of the station. After making a rough determination of the center of gravity, determine which way to orient the stand so that the probe station is conveniently oriented.

After orienting the stand, follow step 2 in the stand setup instructions. The probe station must now be unpacked and placed on the table.

1 Remove the cardboard surrounding the box containing the probe station. Remove the screws around the top edge of the fixture. Five crossbars are under the top; two of these are visible in the photo above. Remove the horizontal screws attaching these crossbars to the sides. Pull off the top and crossbars.

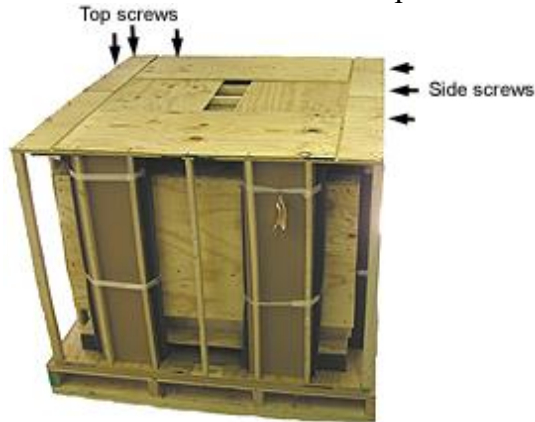

Shipping fixture after cardboard removal

2 Two opposite sides need to be removed to access the bolts holding the probe station to the fixture. All four sides can be removed if desired.



Shipping fixture after removing top and two sides



The probe station is bolted to wood at four locations. Reach under the probe station and remove the nuts. The probe station is now ready to lift out of the fixture.

4

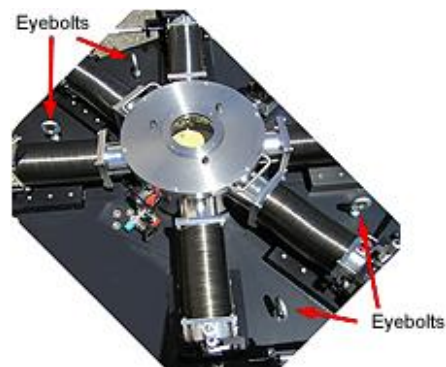

The probe station is very heavy and is best lifted with a crane or forklift. Lift points are provided by eyebolts in the base plate as shown above.



While moving the probe station, be sure micrometers under the probe station base clear the fixture and stand.

While lowering the station onto the stand, be sure the station is oriented correctly as discussed previously. Center the probe station on the stand and lower it the remaining distance. The station does not attach to the stand, but simply rests on it. Remove the eyebolts.

5 Follow the remaining setup instructions for the stand, bearing in mind that it does not come with a table top (the probe station rests directly on the stand). The instructions specify that the isolator load disks must be concentric over the clamp rings. This has already been done by taping the disks to the rings. Once the probe station is placed on the stand, the tape should be removed.

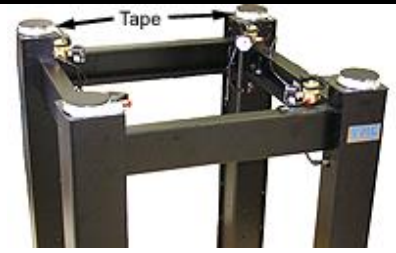

6 Using wire cutters, cut the plastic ties from the X-axis hand dials. Remove the tape (if any) from the Z-axis micrometers. Remove the foam (if any) from under the YZ assemblies.

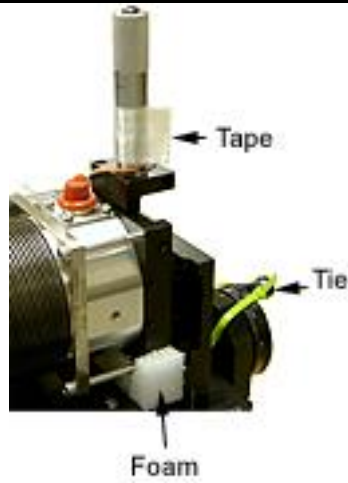

7 Remove any protective cap from the end of the cryogen inlet port on the bayonet. Unscrew the compression fitting from the port, removing the two metal parts and the o-ring. If the o-ring does not come out, use a finger or small tool to gently remove it. Later the fitting is installed on the transfer line; this process is described in the Operation section.



8 Remove the protective cap from the NW25 vacuum connection. The clamp and centering ring are used when the vacuum hose is attached during assembly.

The probe station is now unpacked. Remove dust from the probe station with compressed air or by lightly wiping with a clean cloth.

2.2.2 Vision System

The vision system is packed in the accessories box. The microscope components are packed in bubble wrap and boxes. The display is packed in its original packaging. A separate box contains much of the rest of the optics: the light source, CCD camera and power supply, microscope vertical post and horizontal boom, and miscellaneous support items. Unpack these components and set them out in preparation for completing system set-up and assembly.

2.2.3 Transfer Line

To unpack the transfer line, cut the bands holding the cover onto the bottom of the long flat box and remove the cover. Cut the plastic ties holding the transfer line in place and lift the transfer line from the box. The transfer line is best stored by hanging it on hooks on a wall.

The box also contains the valve actuator, used to re-evacuate the transfer line if that becomes necessary. The valve actuator should not be needed for at least two years. Its use is described in the Troubleshooting section. Store it until needed.

Remove the clevis and cotter pins from the box.

2.2.4 Temperature Controller

The controller is usually packed in the accessories box. To unpack the controller, open the top of the box, remove any cables, power cords, and accessories, remove the top foam fixture, and remove the controller from the box. The manual and/or additional accessories may be located below the controller. Consult the controller manual for further instructions for unpacking, inspection, and set-up of the controller.

2.2.5 Turbo Vacuum System

Open the box and remove all plastic wrap and ties. Remove the vacuum hose from the plastic bag. The vacuum system can be left on the floor near the probe station or placed on a cart.

2.2.6 Tools, O-Rings, and Hardware

The toolkit and other parts shown below come wrapped together in bubble wrap. The hex keys and lifter tool are needed during assembly and operation. The wrench, hardware, and o-rings are used for maintenance or configuration changes. Some additional parts may be included depending on your configuration.

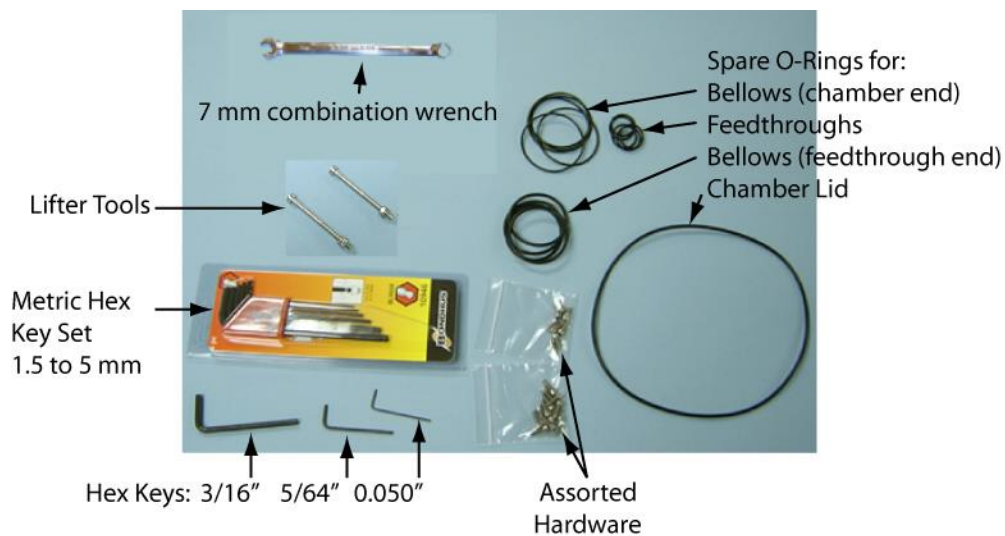

2.3 Assemble the Turbo Vacuum System

The photo at right shows the assembled turbo vacuum system. The diagram below illustrates the connections of the turbo vacuum system components. Most of these components have already been assembled. The steps below illustrate how to make the remaining connections.



Turbo Vacuum System

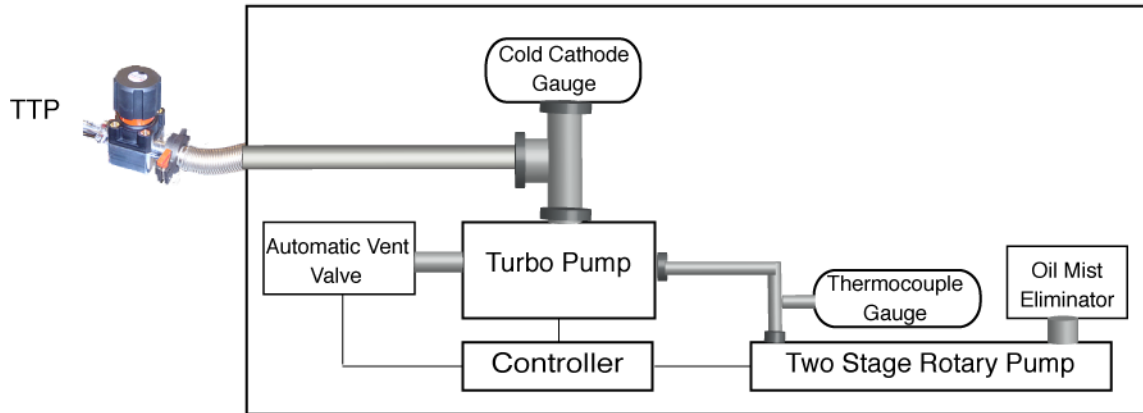

1

Cold Cathode Gauge attaches here



Cold Cathode Gauge

If the cold cathode gauge is not already installed on top of the turbo pump, remove the protective caps, then use the provided clamp and center ring to attach the gauge.

2



Remove the protective cap from the connector on top of the cold cathode gauge. Attach the supplied cable to this connector.



Attach the other end of the cable to the CCG connector on the back of the gauge controller.

3



Using the supplied cable, connect the thermocouple gauge to the TC1 connector on the back of the gauge controller (the back of the controller is shown in the photo in the previous step). The TC2 connection on the gauge controller is not used. If a second gauge cable has been included, disregard it.

4



Remove the protective cap from the top of the oil mist eliminator. Your cap may look different.

If you will be using an exhaust system, connect your vacuum line to the top of the oil mist eliminator. If not using an exhaust system, be sure the cap is off during pump operation, otherwise the pump may force the cap off.

5

Your system may come with oil already installed in the rotary pump. Check that the oil level is between the two arrows. Top off with the supplied oil if necessary by adding oil through the top of the pump.

If your system does not already have oil, add oil through the top of the pump using the supplied oil. Continue adding oil until the level is between the two arrows. See the manual supplied with the pump for more detailed instructions.



6

Remove the clamp and protective cap from the fitting shown at right. The center ring may come out; retain the ring to use in the next step.



7



Holding the center ring in place, set the vacuum line against the ring then close the clamp around the fitting. Tighten the clamp with the screw.

8

Attach the other end of the vacuum line to the probe station's vacuum isolation valve with the clamp.



Important: use the plastic clamp and plastic center ring that

come already installed on the probe station. These plastic components electrically isolate the vacuum valve from the turbo vacuum system. This eliminates most of the electrical noise that might otherwise be coupled from the vacuum system to the probe station, and also eliminates a potential ground-loop in the system.

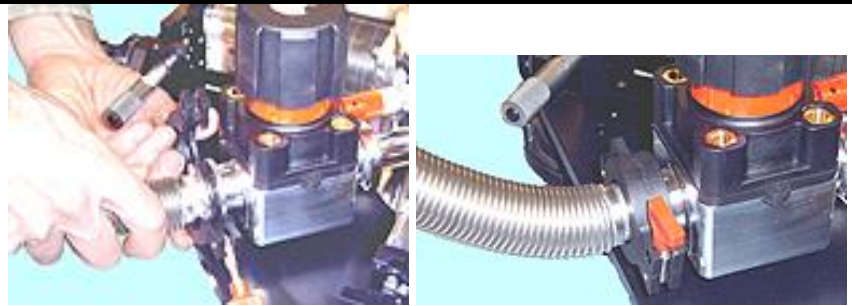

9

To minimize the transfer of vibration to the probe station, the vacuum line from the vacuum system to the probe station should have at least one 90° bend in it. If necessary, the clamp shown in the photo at right can be loosened to rotate the tubing and change the angle of the vacuum line relative to the probe station.

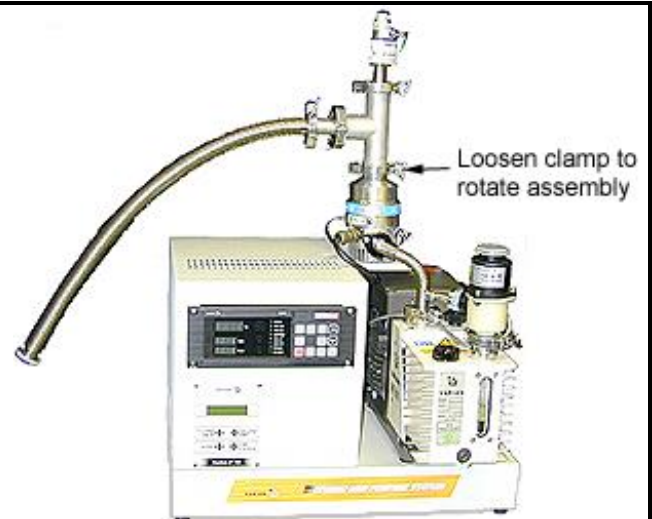

10

Connect the power cord to the turbo vacuum system.

2.4 Assemble the Vision System

The figure at right illustrates the assembly of a single post microscope and CCD system. The vertical post, horizontal boom, microscope, and CCD camera are connected to the probe station base. The horizontal boom rests on the shaft collar on the vertical post. The position of the shaft collar determines the height of the microscope above the sample, and may require adjustment after assembly of the vision system. The details of the adjustment are discussed after the assembly steps are shown.

The optional Optem Zoom 160 microscope uses two vertical posts, requiring both holes in the probe station base. The longer post is installed in the same hole that the regular microscope uses, shown at right. The shorter post is installed in the hole farthest from the chamber.

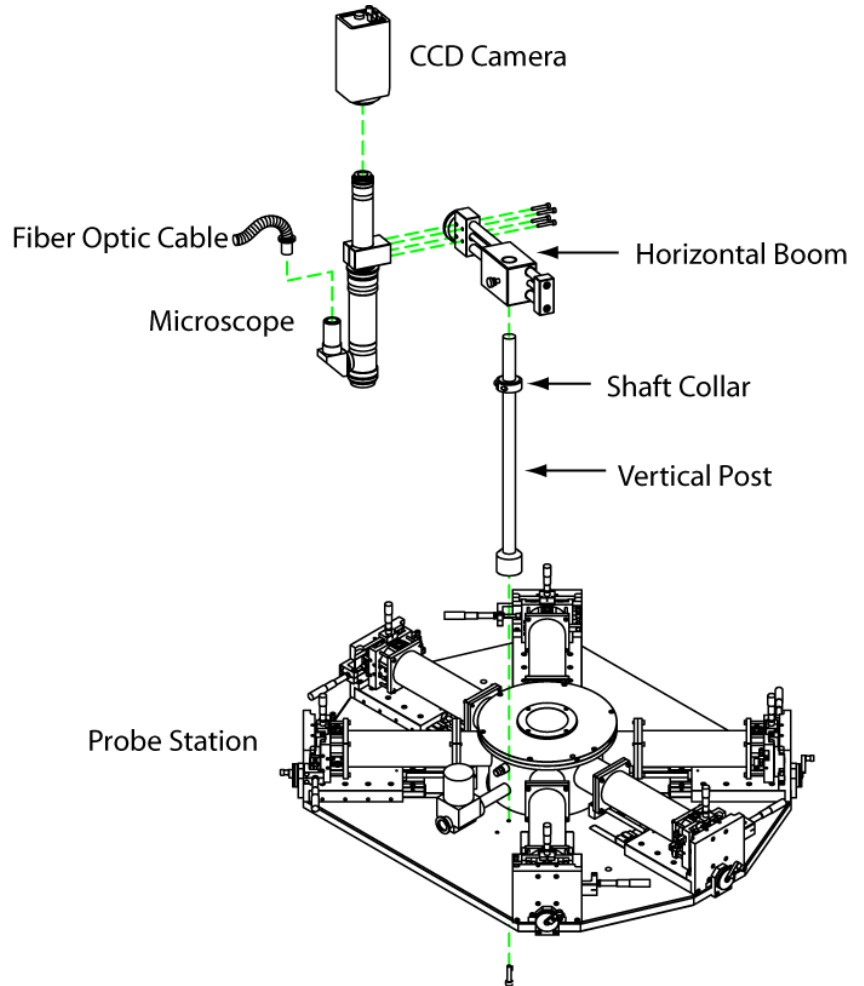

1 Install the microscope vertical post as shown. To install the post, remove the M6 screw in the bottom of the post. Place the post over the hole in the base that is closest to the chamber, then put the screw through the base and in the bottom of the post using a 5 mm hex driver. Tighten until snug.

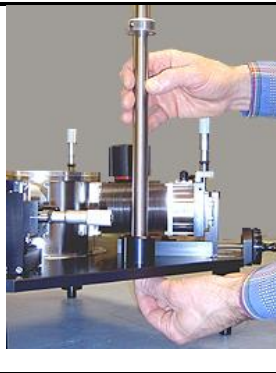

2 Remove the four M4 mounting screws from the microscope using a 3 mm hex driver.



3



Attach the microscope to the horizontal boom with the screws that were removed in step 2. The microscope attaches beside the hand dial. The screw heads go in the recessed holes.

4

Slide the horizontal boom onto the vertical post.



5

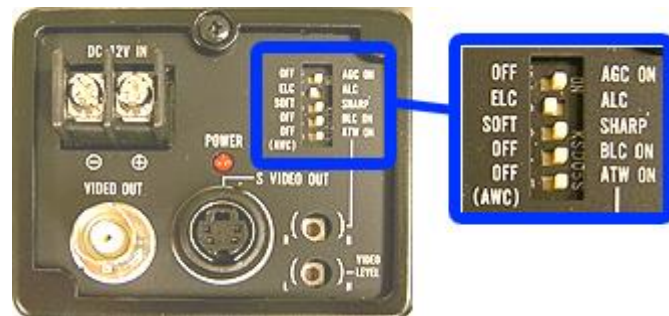

The switches on the back of the camera should be in the same positions as those shown above.

6



Remove the protective caps from the top of the microscope and the CCD camera, and then screw the camera onto the microscope.

7

Attach the power supply leads to the camera using a screwdriver. The red lead attaches to the positive terminal.



8

Plug the S-video cable into the back of the camera. Connect the other end of the S-video cable to the monitor.



9



If not already installed, screw the ring light adapter onto the bottom of the microscope.

10



Slide the ring light onto the adapter. Be sure that the cable is up.

11



Tighten the thumbscrews into the groove on the adapter.

12

Attach the other end of the fiber optic cable to the light source, tightening the thumbscrew. The light control on the front of the lamp housing should be set at the minimum level necessary to produce a clear and well-illuminated image on the monitor.



13

Plug in power cords to the light source, camera, and monitor. Turn the equipment on.

Below the threaded joint to the CCD camera is a rotating joint. Loosen the three set screws on this joint using a 5/64-inch hex driver and rotate the camera so the image on the monitor is oriented logically. The objective is to rotate the camera until the monitor image corresponds to the expected image, e.g., the bottom left probe appears in the bottom left of the monitor screen. Retighten the set screws after adjustment.



14

Bring the sample holder into focus. If you are not able to focus on the sample holder even at the extremes of the microscope's focus knob, the microscope height is probably wrong. Adjust the microscope height by first loosening the nylon thumbscrew on the horizontal boom. While supporting the microscope with one hand to prevent it from falling, use a 3/16-inch hex driver to loosen the shaft collar. Slide the microscope and collar up or down a few millimeters and tighten the shaft collar and thumbscrew. Attempt to focus again. Continue adjusting the height until the sample holder can be focused, bearing in mind that the sample will be higher than the sample holder. If you still cannot focus, see the Troubleshooting section or the microscope manual.

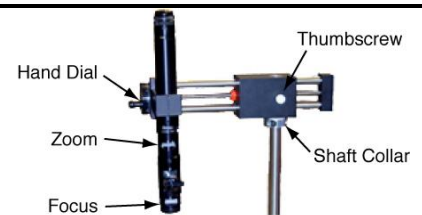

2.5 Install Probes

Probes are installed at the ends of probe arms, inside the chamber. The chamber and radiation shield must be opened. For this initial setup, the sample holder is removed before probes are installed because the sample holder must be removed eventually anyway; it is easier to remove the sample holder prior to installation of probes. The probe station may have been shipped with a vacuum in the chamber to help prevent oxidation; the vacuum must be released before removing the lid to the chamber. This process is described below.

2.5.1 Open the Chamber

1



To release the vacuum, slowly open the vacuum isolation valve by turning the hand knob on the top of the valve counter-clockwise. The valve is open when the red band is visible beneath the knob.

2



Remove the chamber lid by loosening the six outer M6 × 16 mm screws using a 5 mm hex driver.

3



Remove the radiation shield lid by loosening the 10 outer M3 × 8 mm screws using a 2.5 mm hex driver.

4



Using wirecutters, cut the plastic ties holding the cable ends to the probe arms. While cutting, the ties can be held with tweezers to more easily catch them. Discard the cut ties.

2.5.2 Remove the Sample Holder

The probe station is usually shipped with a sample holder installed. Because it is easiest to remove the sample holder before the probes are installed rather than afterwards, the next step is to remove the sample holder. To allow better access to the sample holder, be sure all probe arms are retracted in the X-axis.

1 If you have an optional triax or coax sample holder, the connection must be opened before removing the sample holder from the cold head. Tweezers or pliers can be used to open a coax or triax connection.



If tweezers are used, be very careful that they do not slip off the connector and onto the wire, where they can accidentally pull the wire out of the connector. If pliers are used, squeeze the connector very gently to avoid crushing it.

With the tweezers or pliers, pull the connector out of the sample holder connection. The connector can be left as shown at right.



Coax or triax sample holder connection after opening.

2 If there are clamps installed on the sample holder, remove two opposite ones using a 2 mm hex driver.

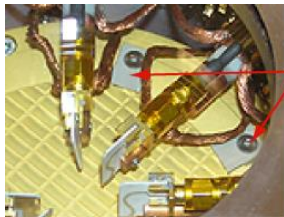

Clamps



Lifter screws



Lifters attached to the sample holder

Two screws (lifters) are supplied to lift the sample holder. Screw the lifters into two opposite clamp holes until the nuts gently seat. Using a 3 mm hex driver, loosen the six M4 screws that attach the sample holder to the cold head. The screws can be lifted out with tweezers, or left in their holes and lifted out with the sample holder. Using the lifters, lift out the sample holder and screws. Store the sample holder in a clean place until needed.

2.5.3 Install a Probe



The probes are packaged separately to protect the delicate tips. Do not touch the tips. Do not handle the alumina blade on the ZN50 probe with bare hands as this may reduce its isolation to ground.



For the ZN50, microwave, or fiber optic probe, follow the first two steps below. After that, use the unique instructions for each probe type, then the common step of attaching the braid block.



ZN50 probe

1 Using the X-axis hand dial, extend the probe arm into the chamber until the probe arm set screws are accessible (the set screws are labeled on the diagram in the How It Works section, and are seen in the photos below).

2 Apply a small amount of vacuum grease, such as Apiezon brand grease, to the probe pin. The grease enhances the thermal contact between the probe and the probe arm.



2.5.3.1 Installing a ZN50 Probe



Slide the probe pin all the way into the probe arm, with the SMA connector up. The copper probe body should touch the copper end of the probe arm.



Secure the probe to the probe arm by tightening the probe arm set screws with a 1.5 mm hex driver.

3 Tighten the probe arm SMA nut onto the probe's SMA connector.



Important: the back of the SMA plug must be held steady while the nut is screwed onto the probe's SMA jack, otherwise the cable's center conductor can be broken. Hand tighten until snug.



Do not remove the tape covering the SMA plug. The tape prevents contact with the radiation shield curtains (the flexible aluminized strips covering the openings), which would short the guard signal to ground. See Appendix 2, Low Current Measurements and Triax Configuration, for further information on guard signals and grounding.

2.5.3.2 *Installing a Microwave Probe*

1



The photo shows the interior of the bellows with a microwave cable attached to the probe arm. The cable is semi-rigid, therefore the connector must be threaded on at the same time that the probe pin is pushed into the probe arm. Gently lift the cable end as the probe pin is inserted in the probe arm, and carefully start the connector nut. The probe can be rotated slightly to improve the alignment between the cable end and the probe. In the event the parts are misaligned or do not thread together easily, do not force them as this can damage the cable or the probe. Contact Lake Shore or your local representative for guidance in this case.



The photo shows the probe pin almost all the way in and the connector partially attached. After attaching the cable and pushing the probe in the rest of the way, the copper probe body should touch the copper end of the probe arm.

2

Secure the probe to the probe arm by tightening the probe arm set screws with a 1.5 mm hex driver. Reference the photo in the Installing a ZN50 Probe section.

2.5.3.3 *Installing a Fiber Optic Probe*

1



Orient the probe so that the braid block is down and the slit in the probe tip is vertical. Slide the probe pin all the way into the probe arm. The brass probe body should touch the copper end of the probe arm. Secure the probe to the probe arm by tightening the probe arm set screws with a 1.5 mm hex driver.

2



Insert the fiber optic tip into the round opening in the probe body. Secure the tip by gently tightening the M3 screw with a 2.5 mm hex driver.

2.5.3.4 Attaching the Braid Block

1



Braid Block Mounting Holes

Using the X-axis hand dial and Y-axis micrometer, move the probe arm to expose the braid block mounting holes in the cold head. Two sets of holes are indicated in the photo above. There are six sets around the perimeter of the cold head, one set for each probe arm.

2

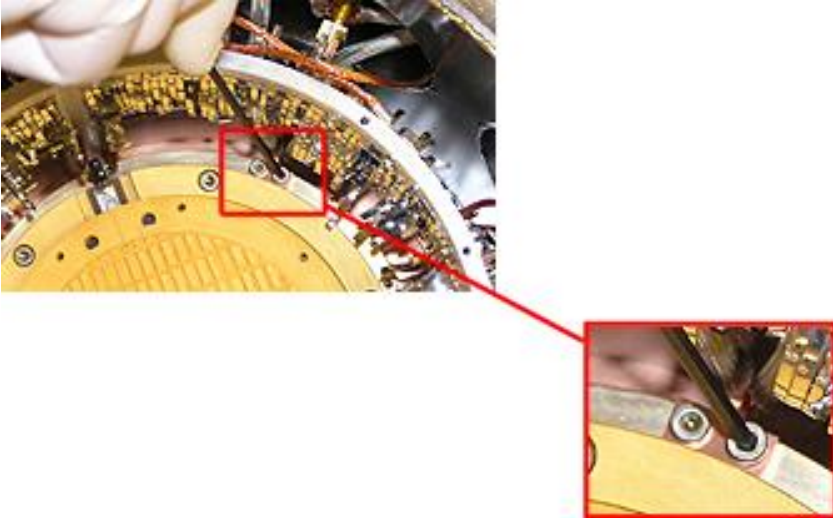

Position the braid block over the holes in the cold head using tweezers. Attach the braid block to the cold head with two M3 × 10 mm screws using a 2.5 mm hex driver. This creates the thermal connection between the cold head and the probe.

If the system will not be used immediately, install the radiation shield lid and chamber lid (see the Opening the Chamber section) to protect the probes and keep the chamber clean. You may also want to evacuate the system to prevent oxidation. See the Operation section for instructions on evacuating the system.

2.6 Attach Cables

There are two types of cables to attach to the probe station: temperature controller cables (supplied with the system) and signal cables.

2.6.1 Temperature Controller Cables

The temperature controller cables connect thermometers (sensors) to the temperature controller and allow the temperature controller to control heaters. As described in section 1, the temperature controller has the capability to monitor two sensors, therefore only two of three sensors can be monitored at one time. The cold head should always be monitored, as this indicates the temperature of the sample. The probe arm or radiation shield temperature can also be monitored.

For heating of the radiation shield, the probe arm sensor cable must be disconnected and replaced with the radiation shield sensor cable. The curve chosen for channel B on the temperature controller must then be configured appropriately. See the Lake Shore manual for information on calibration curves and configuring the controller.

The sensor/heater control cable shown below connects the probe station to the temperature controller.

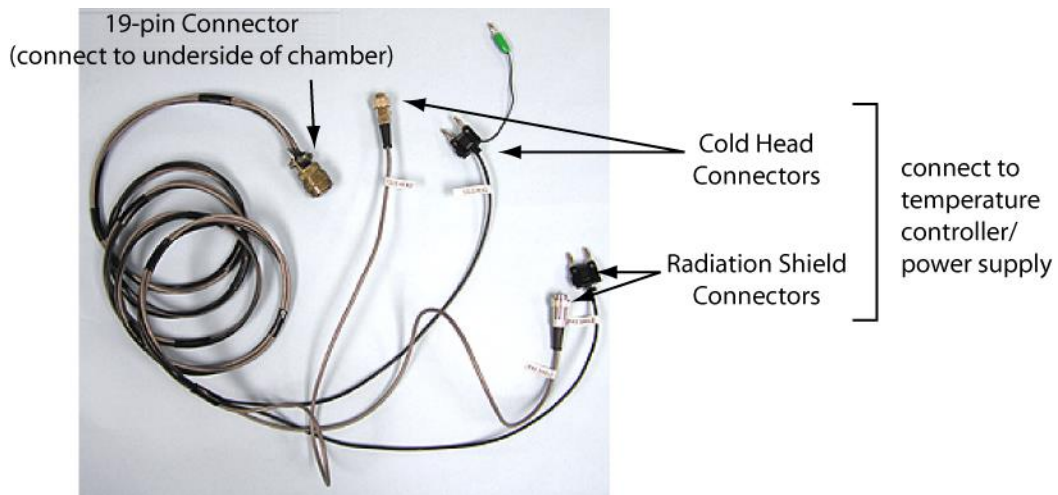

The connection is made on the bottom of the chamber, shown below. There may also be a second connector for optional coax or triax sample holders. Reference this photo in the following steps.

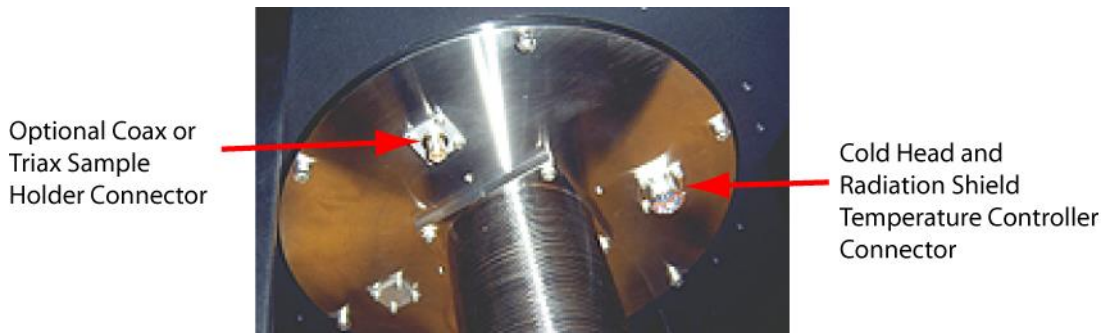

<p>1 Attach the sensor/heater control cable to the 19-pin connector on the underside of the chamber.</p>	<p>The controller end of the cable has lines labeled 'Cold Head' and 'Rad Shield'. On the back panel of the temperature controller make these three connections:</p> <ol style="list-style-type: none"> 1. The cold head DIN connector to Input A 2. The green banana plug to the ground 3. The cold head dual banana plug to the Heater Output terminals, with the ground tab positioned at the LO terminal <p>These connections allow the temperature controller to sense the cold head temperature and heat the cold head. The 'Rad Shield' connectors are addressed in the next section.</p>	
---	---	--

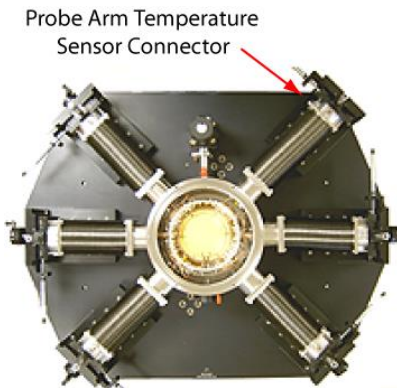
2

One stage has a probe arm temperature sensor. That stage is usually located in the position shown in the photo above, although your configuration may differ.



The probe arm sensor cable connects to the 6-pin temperature sensor connector.

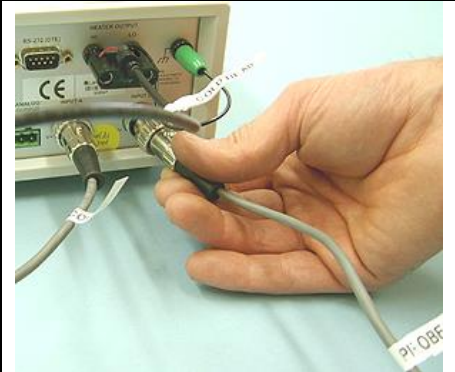

If you choose to monitor the probe arm temperature (see the How It Works section for a description of cable choices), connect the other end of the probe arm sensor cable to the temperature controller by attaching the DIN connector end of the cable (labeled 'Probe Arm') to the Input B connector on the back of the temperature controller.

2.6.2 Radiation Shield Heater

The radiation shield heater may be used to a temperature of 400 K. The heater is 100 W, driven by a maximum of 50 V at 2 A. The Protek Model 6030R Power Supply is capable of an output of 60 V and 3 A. If the power supply is operated remotely by a temperature controller, ensure that an appropriate voltage divider is used on the input cable to the Protek Power Supply so that the output voltage will remain below 50 V. The supplied cable has the voltage divider embedded in it. If the power supply is operated manually, care must be taken to limit the output to 50 V.

Note that there is an error in the manual for the Protek Power Supply regarding the connections to the output. The correct configuration is as follows:

- Connect the shorting bar across the ground (black) and + (red) banana terminals.
- Connect the heater across the ground (black) and – (white) terminals.

If the connections are not made in this way, the unit will not operate in remote mode. The correct configuration is shown in the photo in the following instructions.

1

Connect power cables to the temperature controller and auxiliary power supply (see the supplied manuals). Set the controller and auxiliary power supply power switches to **OFF**.

2 The 'Cold Head' connections of the sensor/heater control cable were made in the previous section. The 'Rad Shield' connections should now be made.

Connect the dual banana plug labeled 'Rad Shield' on the sensor/heater control cable to the front panel of the auxiliary power supply. Ensure that the ground tab is positioned at the GND banana terminal. See the photo at right. This connection sends power to the radiation shield heater. (Notice that the shorting bar is across the black and red terminals.)

To monitor the radiation shield temperature (necessary when using the radiation shield heater), disconnect the Probe Arm DIN cable from Input B on the back of the temperature controller, then attach the 'Rad Shield' DIN connector to Input B. The curve chosen for channel B must then be configured appropriately. See the temperature controller manual for information on calibration curves and configuring the controller.



Auxiliary Power Supply front



Temperature Controller back

3 The amplifier/controller connection cable connects the auxiliary power supply to the temperature controller. It has an end labeled 'Protek'. Connect the flying leads on that end to the '+' and '-' back panel connection terminals on the auxiliary power supply as shown at right (also see the auxiliary power supply manual, page 17, Figure 6). Ensure that the black ground lead is connected to the lower '-' terminal.

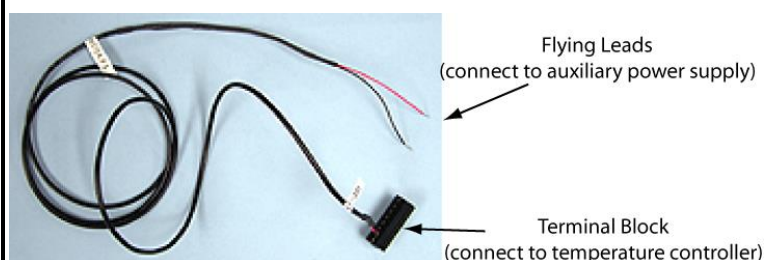

Amplifier/controller connection cable with terminal block

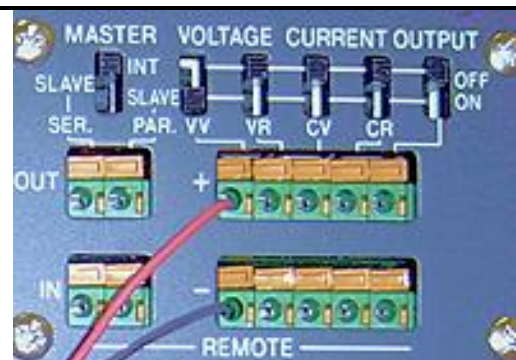

Connect the other end of the cable to the back of the temperature controller. The connector type depends on whether you are using a Lake Shore Model 340 or 331 temperature controller. Both controller types are shown below. If you have a Model 331 temperature controller, connect the amplifier/controller connection cable terminal block connector to the back panel terminal connection slot. The photo in step 2 also illustrates this connection.

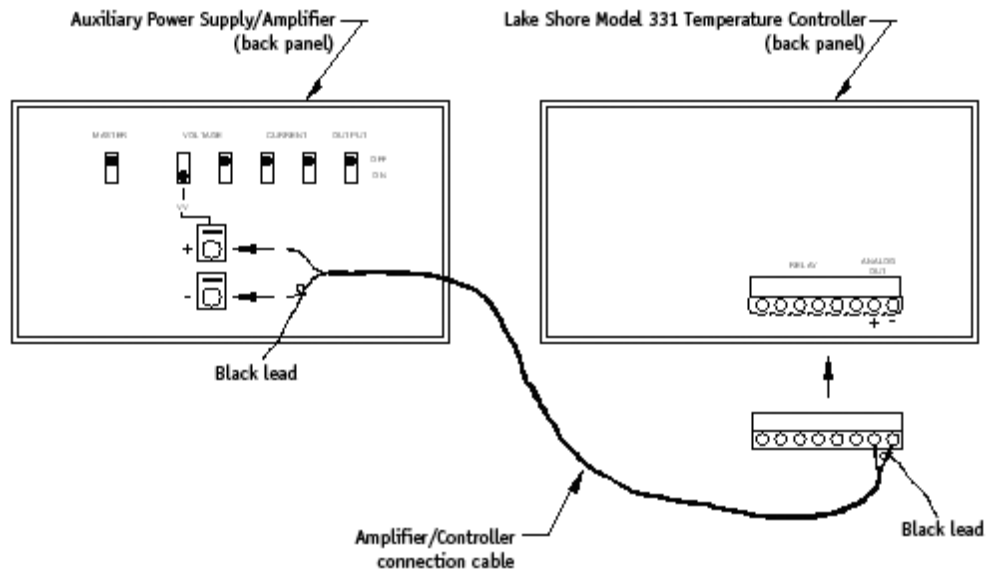

If you have a Model 340 temperature controller, connect the amplifier/controller BNC connector to the Analog Out 2 back panel BNC connection terminal.

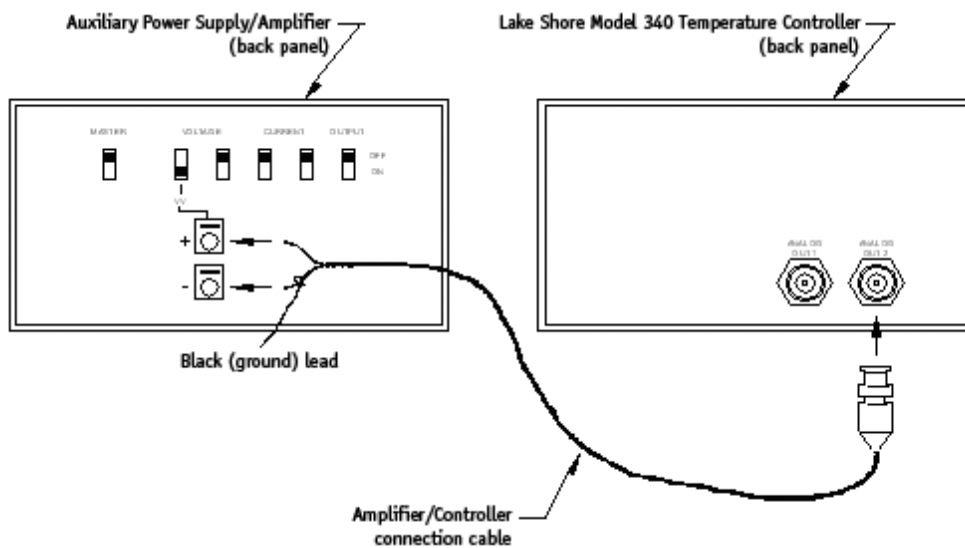

4 On the auxiliary power supply back panel, set the VV switch On (down) and all others Off (up), as shown in the diagrams and photo in step 3.

Set the front panel switches and dials as follows:

- Power = OFF
- CC set = OFF (un-depressed)
- Output = OFF (un-depressed)
- Current dial = Fully clockwise
- Fine dial = Fully clockwise
- Coarse dial = Fully clockwise

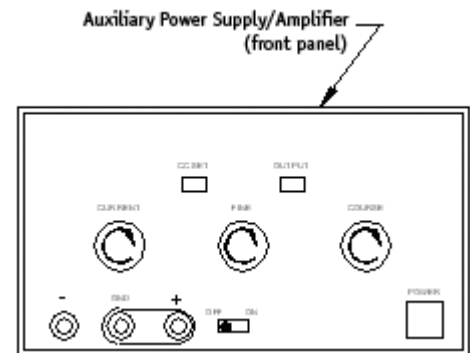

5 Set the temperature controller power to **ON**. If you have a Model 331 controller, ensure that the analog output is set for 0 V output (see the Lake Shore Model 331 manual). If you have a Model 340 controller, ensure that the analog output 2 is set for 0 V output (see the Lake Shore Model 340 manual).

Set the auxiliary power supply main (front panel) switch to **ON** (depressed). Set the auxiliary power supply output (front panel) switch to **ON** (depressed).

6 Configure the Model 331 analog output (or analog output 2 of the Model 340) to control Loop 2, and set the control channel of Loop 2 to be channel B. See the Lake Shore manual for more information.



Incorrect configuration can lead to a ‘runaway heater’ condition.

2.6.3 Signal Connections

1 Remove the protective caps from the signal connectors, then attach your signal cables.

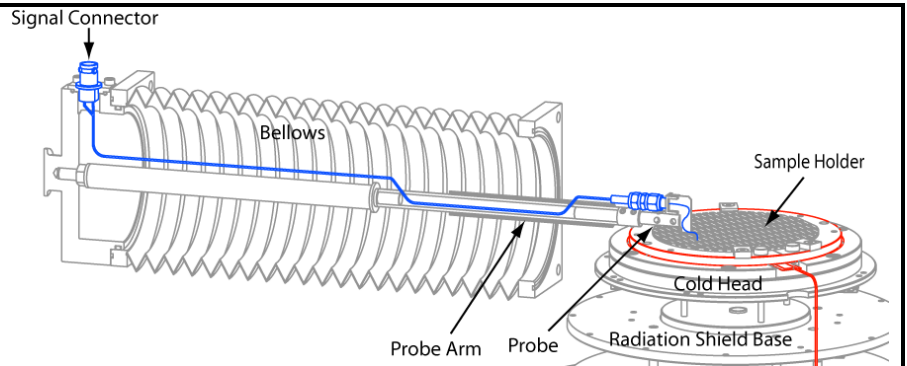

2 If you are using an optional coaxial or triaxial sample holder, attach your cable to the underside of the chamber. The cable provides bias voltages or ground to the sample holder. Attach the other end to your equipment.

2.7 220 V Operation

The probe station system typically includes several ancillary electrical devices. Some of these can be operated on the specified input voltage only. Others must be set for the proper voltage, and the rest have switching power supplies, which can be safely used within a given voltage range. All equipment has been preset to the voltage specified when the equipment was ordered and no changes are necessary. However, if the equipment is moved to a location where different voltages are used, some changes will be required. The table below indicates whether the equipment is changeable and the action required allowing a different input voltage. See the manuals for the equipment for more information on configuring the devices for different input voltages.

Component	Input Voltage	Action Required
Lake Shore Temperature Controller, Model 331 or 340	100–120, 220–240 VAC; 50 or 60 Hz	Change fuse block to appropriate setting
Protek Auxiliary Power Supply	100–230 VAC	Change fuse block to appropriate setting
Light Source	As ordered (120 or 240 VAC)	NOT FIELD CHANGEABLE
Varian Vacuum Turbo System	As ordered (120 or 240 VAC)	NOT FIELD CHANGEABLE
Video Monitor	100–240 VAC	None (switching power supply)
CCD Camera Power Supply	100–240 VAC	None (switching power supply)

3. Operation

3.1 Required Tools

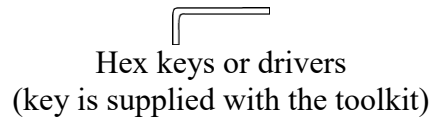

3.2 Select a Probe Type

If you have not already installed probes, follow the instructions in the Assembly section.

3.3 Load a Sample

A full size sample may be loaded onto the sample holder using the supplied guide pins. The two pins closest to one another are arranged to fit the flat surface of a full size wafer.



Guide pins

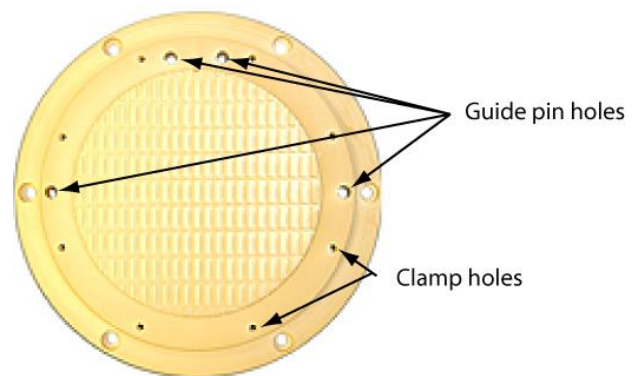

The sample can be secured to the sample holder using the supplied clamps and M3 flat head screws. A 2 mm hex ball driver should be used since ball drivers are more easily inserted into the screw and the chance of an accidental slip into the wafer will be reduced. Start the screws by hand and then tighten securely but with caution, since wafer damage can occur if these clamp bolts are over-tightened. Two opposite clamp holes should be left open for the lifter screws. Once the wafer is mounted, the guide pins must be removed. If the pins are not removed, the probe tips can be damaged from accidental contact.



Clamps

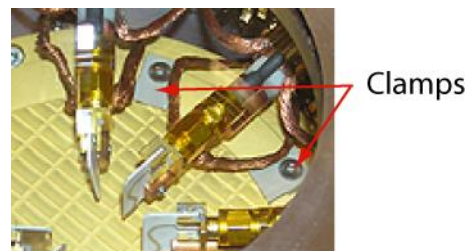

Either full size wafers or smaller samples can be mounted to the sample holder by using photo-resist agents or PMMA by applying a drop of either material onto the sample holder pads and then baking per the material specifications. The resist, chemicals to remove it, and the bake procedures must be compatible with the wafer, sample holder, plating materials, and the devices thereon.

For the optional electrically isolated sample holders, the sample can be mounted to the sapphire in the same manner. Small samples can be mounted using vacuum grease, such as Apiezon brand.

Before attaching the sample holder to the cold head, make sure all probes are lifted (Z-axis) about 4 mm above the wafer, center the probes in the Y-axis, and retract them fully in the X-axis. This will provide maximal clearance for access to the cold head.

The sample holder can be lowered onto the cold head using the supplied screws as lifters. Install the sample holder into the chamber with the two wafer guide pins facing the front of the probe station. The sample holder is fastened with six M4 screws using a 3 mm hex driver. Start the screws by hand to prevent cross-threading, and use the driver only after the screw is started. The six screws should be tightened very securely because this is the source of thermal contact between the sample holder and the cold head.



Coax and Triax Sample Holders. If you have an optional triax or coax sample holder, be sure to orient the sample holder so that the connector is next to the connector in the radiation shield. Attach the connector inside the radiation shield to the connector on the sample holder. The two connector halves have white dots on their tops to help avoid installing upside down. Both halves should have their white dots up. Tweezers or pliers can be used to push the radiation shield connector into the sample holder connector.



If tweezers are used, be very careful that they do not slip off the connector and onto the wire, where they can accidentally pull the wire out of the connector. If pliers are used, squeeze the connector very gently to avoid crushing it.

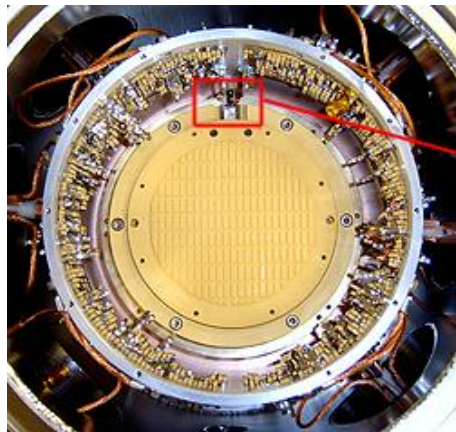

3.4 Seal the Chamber

1

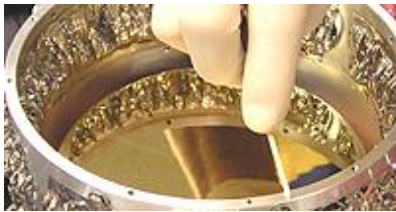

Apply vacuum grease, such as Apiezon brand grease, to the edge of the radiation shield to provide a thermal contact with the radiation shield lid.

2

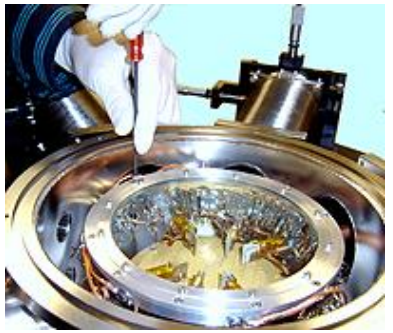

Attach the lid to the radiation shield body with 10 M3 × 8 mm screws using a 2.5 mm hex driver.

3



Clean the chamber o-ring and o-ring mating surfaces. Place the o-ring in the chamber groove.

4 Place the chamber lid onto the o-ring. Attach the lid with M6 × 16 mm screws, using a 5 mm hex driver. The lid will be held tightly in place when the vacuum is applied, therefore if the system will not be moved, it is sufficient to use as few as two screws to hold the chamber lid in position. The screws need not be tightened, but rather screwed in only enough to position the sealing surfaces. If the system is to be moved or shipped, all the screws should be used and tightened gently.



3.5 Evacuate the Chamber

Before evacuating the system, check that all probes are clear of the wafer (lift all probes nominally 4 mm up from the wafer).

1 If your system is equipped with the optional purge valve, close the valve.



2 Open the vacuum isolation valve. The valve is open if the red band is visible beneath the hand knob.



3 Start the turbo vacuum system and press the EMIS button to enable the ion gauge reading (or program the Auto On function to start the emission at approximately 5×10^{-2}). See the vacuum system documentation for information on the system. After starting the vacuum system, the bellows should almost immediately stiffen and after about 30 seconds the rotary pump should stop gurgling. The Cold Cathode Gauge (CCG), shown as the IG (ion gauge) readout on the vacuum system, should register within about three minutes. If this does not happen, press the stop button on the pump and check that the chamber lid is properly sealed. Note that four seconds after stopping the pumping system, an automatic valve will backfill backward through the pump, safely stopping the pump. To prevent venting the vacuum system, the vacuum isolation valve must be closed.



If the vacuum line to the system is evacuated, the vacuum isolation valve closed and the pump on, it is not recommended to just open the vacuum isolation valve. Although this will not immediately destroy the vacuum pump, it will decrease its life. The proper way to proceed is to stop the pumping system, wait for it to vent (it vents itself slowly backward through the turbo), open the vacuum isolation valve, and then restart the pumping system. **Note:** four seconds after stopping the pumping system, it automatically (and safely) vents itself backward through the turbo. If you do not want the system vacuum vented, you will need to install a valve between the pumping system and the section that should not be vented. The pumping system should be vented when it is off to prevent migration of pumping oil and to prevent venting forward through the turbo pump. Also, see the manual for the pumping system.

3.6 Cool the Sample

A vacuum of below 10^{-4} torr (10^{-4} mbar) is recommended. If condensation of gases on the wafer will not affect the measurement, cooldown can be initiated before that vacuum level is reached. The pumping system provided with the system is capable of pumping to 10^{-5} torr or better.

1 Prepare the transfer line by placing the compression fitting onto the transfer line shoulder. The compression fitting came installed on the probe station's bayonet and was removed during assembly.



2 Close the foot valve, and then open by turning five to six complete turns counter-clockwise.



3 Slowly insert the transfer line into a Dewar. The required port is a 0.5-inch o-ring compression seal. Lower the leg slowly until the Dewar pressure just starts to rise. Close the low-pressure (typically 0.5 psi) relief valve on the Dewar. Monitor the pressure and be sure to keep it below 6 psi. This can be achieved using a relief valve on the Dewar exhaust or by connecting a regulated helium supply to the Dewar exhaust.



The cryogen will leave the target end of the transfer line. Be very cautious that the target end is not directed at people or sensitive equipment.

Continue to lower the transfer line slowly enough that the Dewar pressure does not rise dramatically, until the transfer line leg hits the bottom of the Dewar. The Dewar pressure should be approximately 5 psig. The process of precooling the transfer line is complete when a continuous plume of white vapor is ejected from the other end of the transfer line. The time required should have been approximately 5 minutes. Note the size of the white plume to mentally compare it with earlier, successful precools.



4



Clevis pin installed through the rings.



The cotter pin secures the clevis pin.

Insert the transfer line into the bayonet on the probe station. You may need to wipe ice crystals from the tip of the transfer line before insertion; use a clean cloth for this purpose. Push the transfer line in until it stops, then tighten the outer nut on the compression fitting at the base of the transfer line leg. The transfer is started.

To secure the transfer line in position, insert the clevis pin in the holes in the lower and upper rings. Insert the cotter pin to hold the clevis pin in place.

The process is the same for nitrogen, except the transfer line will cause less pressure rise in the Dewar, and an external source of pressure may be needed.

5 Set the desired temperature on the temperature controller. To continue transfer into the probe station, settings for fast initial cooldown are foot valve fully open (5 to 6 turns open) and Dewar pressure at about 5 psig. Once the probe station is cool, the transfer rate can be reduced. For

temperatures below 60 K, it works well to keep the Dewar pressure at 2 to 3 psig and close the foot valve until the desired transfer rate is achieved. The general procedure is to close the foot valve until the cold head temperature starts to rise, and then continue closing the foot valve until the set-point temperature can be maintained with control heat applied to the cold head. For temperatures above 60 K, the required flow is very small. More efficient long-term transfer is achieved by lowering the Dewar pressure to about 0.5 psig and adjusting the foot valve setting accordingly.

Typical plots for cooldown were shown in section 1.

3.7 View the Sample

Remove the dust cap from the bottom of the microscope. Turn on the monitor, camera, and light source. Adjust the light source to the minimum amount of light necessary to view the sample. Focus and zoom the microscope as necessary. (The microscope shown at right is the standard microscope; optional microscopes may have zoom and focus controls in different locations.)

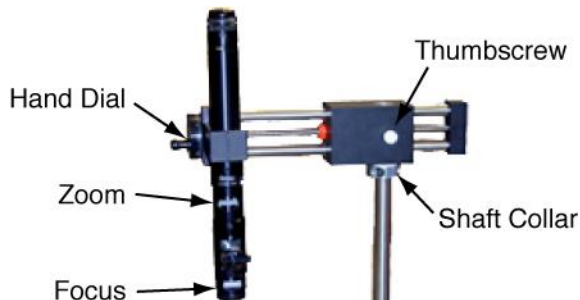

The microscope can be positioned over any spot over the chamber viewport. The two necessary degrees of freedom are provided by the rotation of the horizontal translator around the axis of the vertical post and the extension of the translator. To rotate, loosen the thumbscrew, rotate the microscope, and then tighten the thumbscrew. To extend, turn the hand dial.

Consult the CCD manual in the unlikely event you need to change the CCD camera settings.

3.8 Make Contact

In many cases, the height of the probe above the sample may be known very precisely. For example, if the probe is known to be precisely 4 mm above the sample, focus on the sample and lower the probe approximately 3.5 mm while watching the probe tip. It should come into focus. Then continue lowering the probe, stopping to position it as needed so that it lands right on the edge of the pad. Once it lands on one of the pads (which is indicated by a very slight forward movement, known as 'skating'), continue lowering it until it skates on the pad by a consistent amount. A typical amount of overtravel is 50 μm . The desired position of the probes with respect to the edge of the pads and the desired amount of skating should be determined and used as a lab standard to ensure consistent results. If the position of the probe over the sample is not known, focus on the pads and lower the probe until the probe tip comes into focus. Then lower very slowly as before, watching for the probe tip to start skating, indicating that contact is made.

The range of travel for each probe arm is 125 mm in the axis of the probe arm (X-axis), 52 mm in the plane of the sample perpendicular to the probe axis (Y-axis), and 16 mm in the vertical (Z-axis).

Warning: when retracting the probe, lift it about 4 mm above the sample. Ensure that the probe arm clears the upper edge of the viewport in the radiation shield. Center the probe in the Y-axis (set position to 12 mm) before retracting the probe in the X-axis.



General system warning: the range of the stages in some axes exceeds the range of movement accommodated by the system without interference. When moving near any extreme, take precautions to ensure no interference with probe arms will occur.

3.9 Make Measurements

Refer to the diagram in section 1.2 to see how electrical contact is made with the sample. With the standard ZN50 probes and six stages, it is possible to make six simultaneous connections to the sample.

3.10 Return to Room Temperature

All probes should be lifted 4 mm above the sample. Close the vacuum isolation valve. Turn off the turbo vacuum system (press the start/stop/reset button on the turbo controller front panel).

There are three different procedures for warming the system. They are listed in order of fastest to slowest.

1. To warm the system quickly using both heater and exchange gas in the chamber:

- Enter set points on the temperature controller of 290 K for both loops. The heater output will read 100%. Be careful that the radiation shield heater is being controlled by the correct channel and sensor, or a ‘runaway heater’ condition may cause damaging high temperatures.

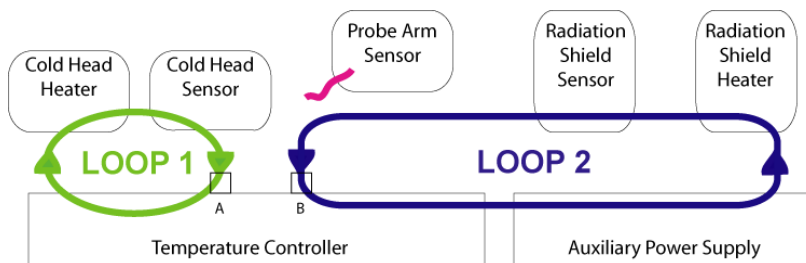

- Five minutes after starting to heat, crack open for a fraction of a second, then close, the vacuum isolation valve. You should hear a short flow of gas. This will spoil the vacuum in the system enough to speed warm-up.
- After another five minutes, slowly and carefully crack the vacuum isolation valve and leave it cracked for about 5 seconds. Close it again.

NOTE: you may want to have the back-to air valve on the pump connected to a source of low pressure (1 psig) dry nitrogen to protect the sample from exposure to moisture when it is cold. This will also help shorten the next pumpdown time by reducing the amount of moisture in the system.

2. To warm the system quickly using the heater but no exchange gas in the chamber:

- Enter set points on the temperature controller of 290 K for both loops. The heater output will read 100%. Be careful that the radiation shield heater is being controlled by the correct channel and sensor, or a ‘runaway heater’ condition may cause damaging high temperatures.

3. To warm the system slowly (overnight) without human monitoring:

- Leave the temperature controller set point at low temperatures to prevent unwanted output from the heater, or turn off the heater and controller altogether.

If the system will not be used immediately, raise the transfer line so the bottom of the Dewar-side leg is out of the liquid cryogen in the Dewar. The Dewar pressure will drop. As the Dewar pressure approaches atmospheric, the transfer line can be removed from the probe station bayonet. Cap the exhaust port on the bayonet and cork the inlet with something that will allow pressure relief should any liquid in the tubing vaporize during warm-up. Remove the transfer line from the Dewar and store it (hang it up somewhere).

3.11 Unload the Sample

After returning to room temperature, release any remaining vacuum in the chamber by slowly opening the vacuum isolation valve. It should take about a minute to vent the system.

Make sure all probes are lifted (Z-axis) about 4 to 5 mm above the sample, center the probes in the Y-axis and retract them fully in the X-axis. Remove the chamber lid and radiation shield lid using the procedures described in Assembly section. Keep the screws together and in a place systematically reserved for these screws, protect the lid viewports, and place the lids in a secure spot.

Remove the sample holder using the procedure described in the Assembly section. Be very careful not to slip; the sample is very near and very easily damaged. Follow the standard procedures for stripping resist to remove the sample from the sample holder.

If the system will remain unused for some time, reinstall the chamber lid (it is not necessary to screw it down) to prevent objects and contaminants from entering the system. Protect the window. You may want to evacuate the system to help prevent oxidation.

3.12 Heating the Sample

The sample can be heated by heating the cold head (and radiation shield, if desired) using the temperature controller. Heating the cold head will heat the sample holder, sample, probe arms, and probes. The cold head can be heated to 475 K and the radiation shield to 400 K. However, some types of sample holders and probes can be heated to only 400 K. The following tables show the temperature limits of the equipment. Exceeding these limits may damage the sample holder or probe.

Probe Type	Temperature Limit
ZN50	475 K
Microwave	400 K
Multi-contact	400 K
Fiber-optic	400 K

Sample Holder	Temperature Limit
Grounded	475 K
Coax	400 K
Triax	400 K
Isolated	400 K

4. Configuration Changes

Configuration changes include changing probe arms and cables and adding stages. Probe arms and cables may need to be changed if you will be using a different probe type. Stages may be added if your original system has fewer than eight stages.

4.1 Changing Probe Arms

Before removing a probe-arm assembly, gather a small tray in which to put the hardware removed from the system. If a planarization assembly (for multi-contact probes) is included on the stage assembly, remove it (refer to the Optional Equipment section for information on removing the planarization assembly).

4.1.1 Removing a Probe Arm Assembly

1 To prevent damage to the probe, remove any probe from the probe arm using the reverse of the installation procedure described in the Assembly section. If the probe arm has a fiber optic cable, tape the cable tip to the end of the probe arm to keep it secure. Cellophane tape is adequate for this purpose.

2 The probe arm has a separate radiation shield. The probe-arm shield is thermally connected to the main radiation shield via two copper braids with spade lugs at the ends. These are screwed to the main radiation shield with M4 hex screws. A 7 mm wrench is provided with the system toolkit. Use the wrench to loosen the hex screws holding the lugs at the ends of the braids, but do not fully remove these screws. Slide the spade lugs from under the screw heads and let the braids fall.

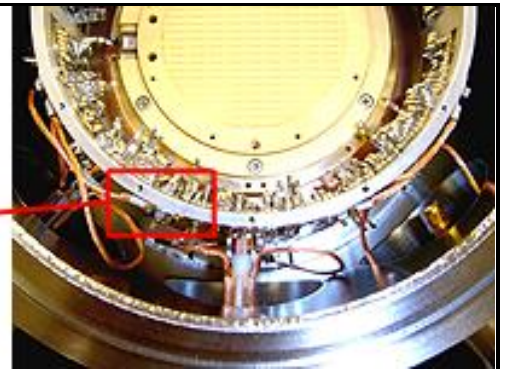

3 Using a 5 mm hex ball driver, remove the four M6 × 16 screws that are installed horizontally near the bottom of the Y-axis base; if necessary, use the X-axis hand dial to move the stage forward to access all of the screws.



4 Using a 5 mm hex ball driver, remove the two vertical M6 × 16 screws in the Y-axis base. There is one screw on each side.

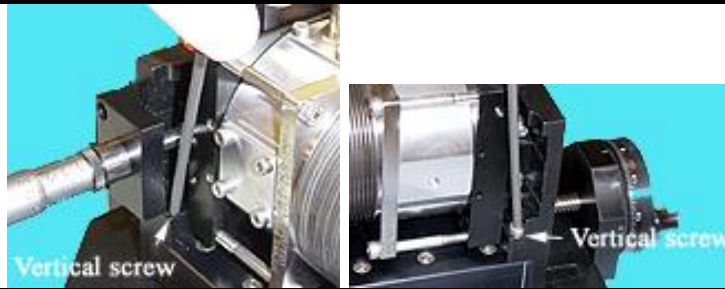

5



Detach the bellows from the chamber using a 4 mm hex driver to remove the four M5 × 16 screws.

6



Support the bellows in one hand, then lift the YZ assembly enough to clear the X-axis base. Gently pull the bellows and cables backwards. Take care that the cable and braids clear the radiation shield and chamber openings without catching. Set the assembly on the YZ base with the probe arm vertical.

7 Remove the four M5 × 45 mm screws that attach the bellows to the Z-axis stage. Work the bellows end flange off the feedthrough housing. This should be done slowly with a great deal of control. Place the bellows on a clean, lint-free cloth or lint-free wipe.



8 The feedthrough housing is loosely secured to the Z-axis base with two stainless steel dowels. These dowels are held in place with M6 set screws. Remove the set screws using a 3 mm hex driver.



Close-up of the set screws. One set screw has the hex driver in it. The other set screw can be seen to the left.

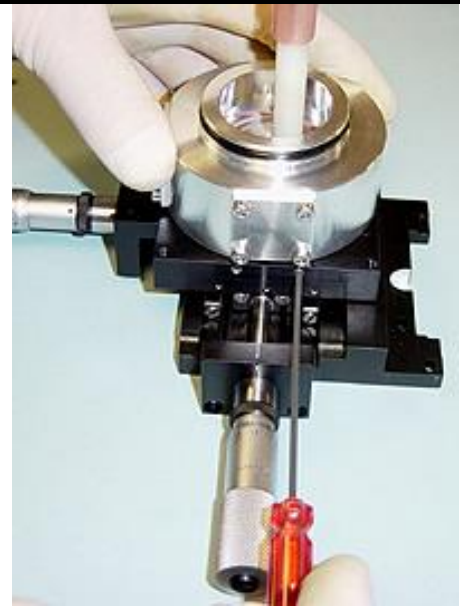

Insert the driver into the opposite side from the set screws and push both dowels out.

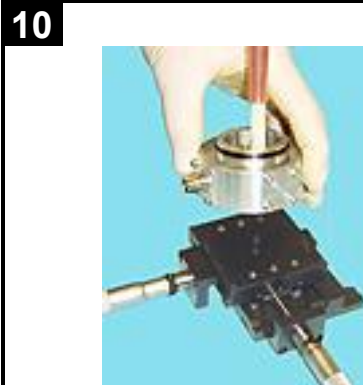

Lift the feedthrough housing/probe arm assembly off the YZ-axis assembly. Store the old probe arm if it is to be used later.



Remove the o-ring in the face-seal groove in the side of the chamber.

4.1.2 Installing a Probe Arm Assembly

If the YZ assembly has not already been removed, remove it using the instructions above.

1

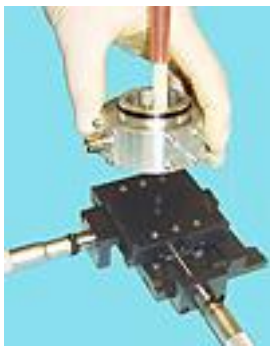

Place the new feedthrough housing/probe arm assembly onto the YZ assembly. Orient the feedthrough housing as shown, with the signal connector aligned with the Z-axis micrometer. Precise alignment is not necessary.

2

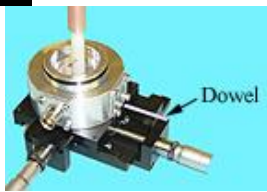

Insert the two dowels into the Z-axis base.

3

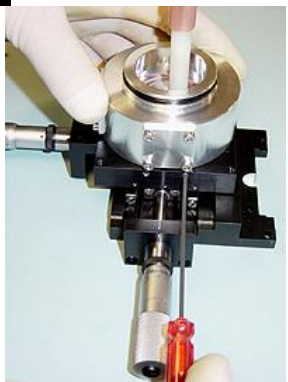

Use a 3 mm hex driver to install the two M6 set screws over the dowels. Tighten until snug.

4 Place the bellows over the cable and carefully push it down until the flange meets the feedthrough housing. Install the four M5 × 45 mm screws that attach the bellows to the YZ assembly, and tighten the screws evenly.



Warning: the four M5 × 45 mm screws holding the bellows flange to the Z-axis stage assembly should be installed to a torque of 16 in·oz (11 N·cm). If these screws are overtorqued, the Z-axis stage will bow and the bearings will loosen; a symptom of this problem is play in the Z-axis micrometer. The torque required, 16 in·oz, is much lower than one might think would be needed. We recommend a torque wrench be used to ensure these screws are not over-torqued.

5



Clean the o-ring groove in the chamber face-seal. Lightly grease the o-ring and place it in the groove.

6



If the probe arm has a flexible cable, temporarily tie the cable to the probe arm to easily put the cable through the radiation shield opening. Place the tie near the end of the cable so it can be removed after the assembly is installed. The white tie can be seen in the photo, just behind the gold cable connector.

7 Holding the stage as shown, with the Z-axis micrometer up and the Y-axis micrometer to the right, move the assembly onto the X-axis base. Take care that the cable and probe arm enter the radiation shield. The copper braids go between the chamber and radiation shield. Set the Y-axis base onto the X-axis base.



8 To hold the bellows in place, start one of the M5 × 16 screws that attach the bellows to the chamber.



9



Using a 5 mm hex ball driver, start the four M6 × 16 screws that are installed horizontally; use the X-axis hand dial to move the stage forward to access all the screw holes.



Start the two vertical M6 × 16 screws, and then tighten all six screws (two vertical, four horizontal) evenly.

10 Attach the three remaining M5 × 16 screws that hold the bellows to the chamber. Tighten all four screws uniformly.



11 Use tweezers to lift a braid. Slide the spade lug under the washer on the radiation shield, and then tighten the nut using the 7 mm wrench provided with the system. Use the same procedure to attach the other braid to the other side of the probe arm.

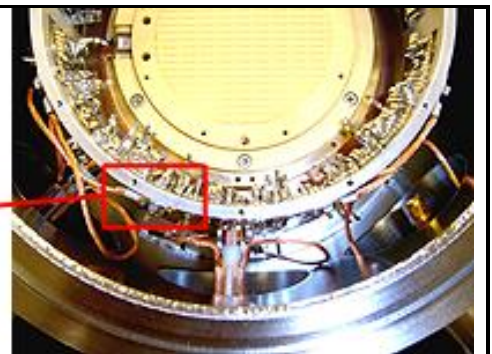

12 Remove the temporary tie holding the cable to the probe arm. You may need to extend the probe arm into the radiation shield using the X-axis hand dial.

13 Install the planarization assembly if required.

14 Install a probe following the steps in the Assembly section.

4.2 Changing Cables

If you will be changing cables frequently, it is recommended to have a probe arm available with the appropriate cable already installed, then switch probe arms using the instructions in the previous section. However, if a cable change is necessary, the following instructions explain the process.

4.2.1 Removing Cables

Begin by removing the probe arm using the instructions in the previous section.

1 If you are removing a semi-rigid or fiber optic cable, cut the string that ties the cable to the probe arm.

2 Use a 2.5 mm hex driver to remove the four M3 × 6 screws that attach the cable feedthrough assembly to the feedthrough housing.

3 If you are removing a semi-rigid or fiber optic cable, pull the cable feedthrough assembly and its attached cable out and off of the probe arm. The semi-rigid cable has bends that require some twisting of the cable feedthrough assembly as the cable is removed.

If you are removing a miniature coaxial cable, lift the cable feedthrough assembly approximately one inch from the feedthrough housing and unsolder the cable from the coax or triax connector. At the other end of the cable, grasp the SMA connector and pull the cable out of the arm while feeding the loose end into the center of the probe arm.

4.2.2 Installing Cables

Lightly grease the feedthrough o-ring and place it in the groove. Replacement o-rings are provided with the TTP's toolkit if it is necessary to replace the o-ring.

Next, use the unique instructions for each cable type.

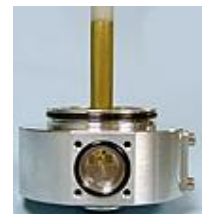

4.2.2.1 *Installing a Miniature Coax Cable*

1 Insert the end of the coax cable without the SMA connector into the hole in the probe arm near the braids. Push the cable in until it comes to the end. The cable will probably come out of the exit hole by itself. If not, use small tweezers to pull it out, being careful not to damage the fragile center conductor. Push the wire through the opening in the feedthrough housing (see the photo in the next step). Reference the drawing in section 1.2, which illustrates the routing of the cable through the probe arm.

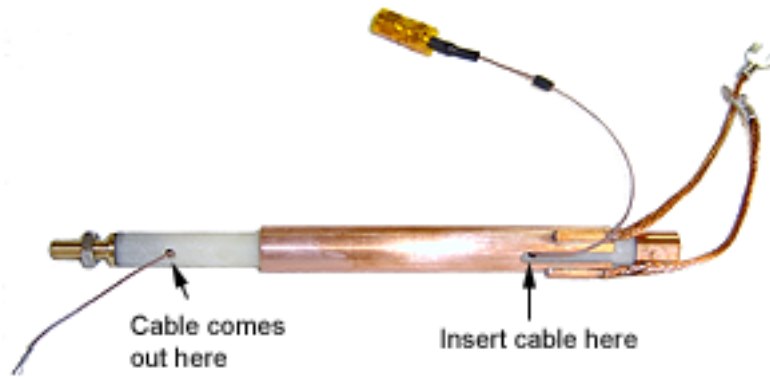

2 Solder the cable ends to the signal connector. The recommended solder is tin-silver (Sn 96% - Ag 4%). The small wire on the cable is the center conductor. On a coax connector, solder the small wire to the center pin on the connector and the larger wire to the outer pin. On a triax connector, solder the small wire to the pin with the white dot next to it, and solder the large wire (the guard) to the other pin. The white dot is visible next to the right-hand pin in the photo at right. Solder the shield first so that the fragile center conductor will not be inadvertently broken off, and use minimal heat to avoid melting the dielectric between the shield and center conductor.

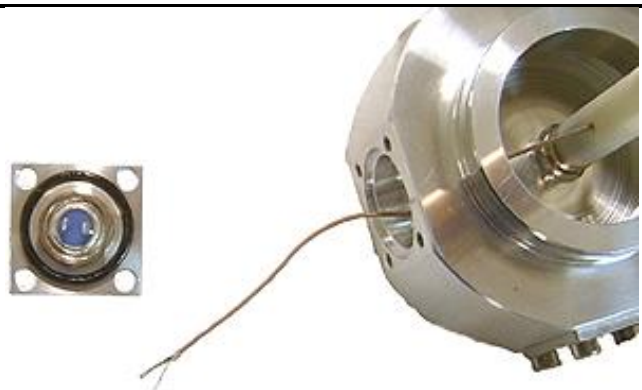

3 Using a 2.5 mm hex driver, attach the cable feedthrough assembly to the feedthrough housing with four M3 × 6 screws. Install the probe arm on the TTP using the steps in the Installing a Probe Arm Assembly section. Install a ZN50 probe using the instructions in the Assembly section.

4.2.2.2 *Installing a Semi-Rigid Cable*

1 Carefully insert the cable into the feedthrough housing. Continue inserting the cable, turning the cable feedthrough assembly as necessary, until the cable feedthrough assembly seats against the feedthrough housing.

2 Using a 2.5 mm hex driver, attach the cable feedthrough assembly to the feedthrough housing with four M3 × 16 screws. Note that the cable does not pass through the center of the feedthrough assembly. Rotating this assembly will change the position of the cable end that attaches to the probe. See the next section, Adjusting the Fit of Semi-Rigid Cables.

3 Apply vacuum grease to the location where the cable will be secured to the probe arm. Tie the cable to the probe arm using unwaxed dental floss.

4 Install the probe arm on the TTP using the steps in the Installing a Probe Arm Assembly section. Install a microwave probe using the instructions in the Assembly section.

4.2.2.3 Installing a Fiber Optic Cable

1 Attach the cable feedthrough assembly to the feedthrough housing with four M3 × 6 screws using a 2.5 mm hex driver.

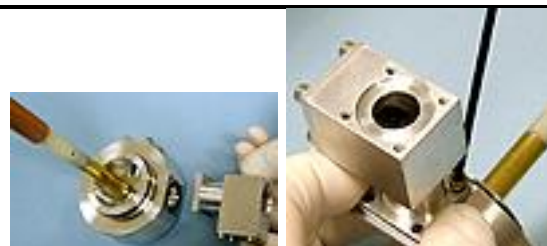

2



Insert the fiber optic tip into the cable feedthrough assembly. Handle the fragile fiber optic cable carefully; it should not be bent sharply or it may break. Pull the cable through until the connector seats against the cable feedthrough assembly. Attach the connector to the cable feedthrough assembly with four M3 × 6 screws using a 2.5 mm hex driver.

Note: do not loosen the nut between the cable and the flange.

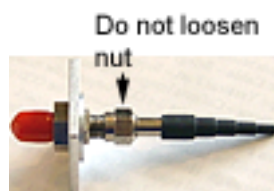

3

Wrap the cable around the probe arm. Using unwaxed dental floss, tie the cable to the arm.

Temporarily tape the fiber optic tip to the end of the probe arm to secure it while the arm is installed on the probe station.

Cellophane tape is adequate for this purpose.

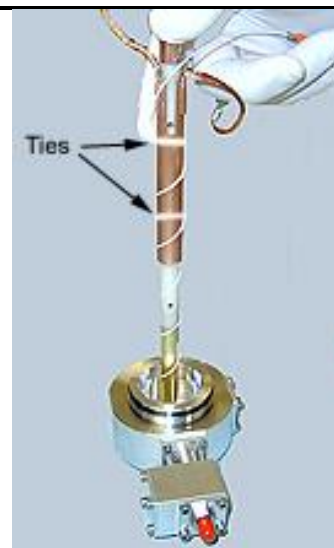

4 Install the probe arm on the TTP using the steps in the Installing a Probe Arm Assembly section. Remove the cellophane tape and install the fiber optic probe using the instructions in the Assembly section.

4.3 Adjusting the Fit of Semi-Rigid High Frequency Cables

A few adjustments can be made to change the relative positions of the cables and the probes. These are listed in order of increasing difficulty. Try the easiest one first.

First method:

1. Remove chamber lid and radiation shield lid. Remove any probe from the probe arm.
2. Adjust the X-axis position (with the hand dial) to enable the end of the cable inside the chamber to be grasped.
3. Remove the four M3 × 16 screws holding the cable feedthrough assembly to the feedthrough housing. The cable passes through an eccentric hole in the cable feedthrough assembly so that rotating the assembly will change the position of the cable. Rotate this to the most favorable position and loosely start the four screws. Gently push or pull both ends of the cable in the desired direction. The cable should be free to slide in the cable feedthrough assembly if the screws are loose, and it should slide through the string holding it to the thermal anchor block on the probe arm with some gentle wiggling of the probe end (inside the chamber.)

Second method:

1. The probe arm assembly must be removed from the system. The probe arm can be screwed in or out of the feedthrough housing to vary the length from the cable feedthrough assembly to the probe.
2. With the probe arm assembly out of the system and the bellows removed, cut off the string holding the cable to the thermal anchor block.
3. Remove the cable assembly.
4. For the probe arm that has the thermometer, remove the 6-pin feedthrough (receptacle), and then unsolder the four wires.
5. Loosen the Locknut, and rotate the probe arm to lengthen or shorten it as necessary. (It may be necessary to modify a wrench to fit down inside the feedthrough housing and access the locknut. The nut is an M6 – 1.0 mm, having a wrench size of 10 mm.)
6. Tighten the locknut while keeping the probe arm oriented properly.
7. Upon reassembly, apply grease to the thermal anchor block and tie the cable down to it with polyester string, such as unwaxed dental floss.

Third method:

If more change in length is required, the 90° bend in the cable must be repositioned to take some from the vertical section and add it to or subtract it from the horizontal section. This can be done carefully by hand. Keep pressure on the inside radius as the bend is made to prevent the cable from kinking.

5. Optional Equipment

5.1 Probes

5.1.1 High-Impedance Measurement Description

The high-impedance measurement option includes a triaxial feedthrough wired with Teflon®-insulated cryogenic coaxial cable to an SMA connector which mates with a Model ZN50 probe. In the triax, the outermost contact is the shield, which connects electrically to the chamber or to chassis ground. The centermost contact is the signal contact, and the contact between the signal and the shield is the guard contact. With the high-impedance measurement option, the assembly, from the triaxial feedthrough to the probe tip, is specified and measured to have a resistance between signal and guard contacts exceeding 10 GΩ. Typically, it is measured at the factory to exceed 50 GΩ. Resistance between guard and chassis and between signal and chassis are both also >10 GΩ.

5.1.2 Planarization Assembly

The planarization assembly must be installed to use either the microwave or multi-contact probes. These probes can be installed on any stage, keeping in mind that the stage with the probe arm thermometer will require a feedthrough for the thermometer.

5.1.2.1 Installing the Planarization Assembly

The planarization assembly allows the probe to be rotated so that all the probe's contacts touch the sample at the same Z-axis position. Attachment of the planarizing assembly is shown below.

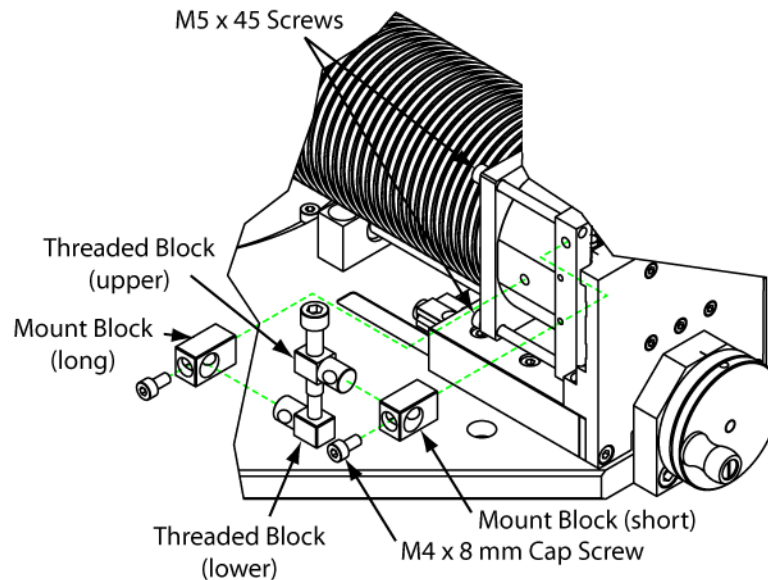

The details of the installation of the planarization assembly are below. Before starting, remove any probe from the selected stage to prevent damage to the probe.

1

Using a 4 mm hex driver, slightly loosen the four M5 × 45 mm screws holding the bellows flange to the Z-axis stage assembly. Do not remove these screws. Simply loosen them slightly to allow rotation of the feedthrough housing.

2

Mount Block
(long)



Insert an M4 × 8 screw into the long mount block. Reach a 3 mm hex driver through the block and attach the screw and block to the feedthrough housing.

3

The threaded blocks should be approximately centered on the screws.

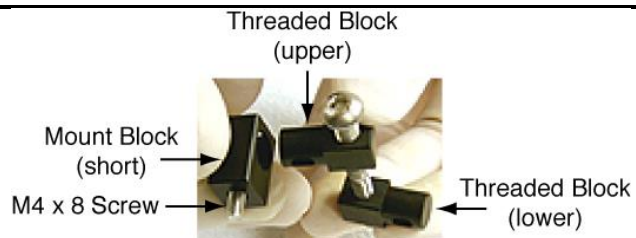

Insert an M4 × 8 screw into the short mount block. Slide the short mount block onto the upper threaded block (the upper threaded block is the one closer to the screw head).

4

While holding the assembly together, slide the lower threaded block onto the long mount block that is already attached to the feedthrough housing. Reach a 3 mm hex driver through the short mount block and attach the M4 × 8 screw. You may need to rotate the feedthrough housing to align the screw with the hole.

5

If a microwave or multi-contact probe will not be immediately installed, use a 4 mm hex driver to tighten the four M5 × 45 mm screws holding the bellows flange to the Z-axis stage assembly. These screws should be installed to a torque of 16 in·oz (11 N·cm).

To remove the planarization assembly, unscrew it from the Z-axis stage end plate and probe feedthrough housing.

5.1.2.2 Using the Planarization Assembly

A differential screw is used to adjust the separation of the two mount blocks, one fastened to the feedthrough housing and one fastened to the Z-axis stage assembly. Turning the differential screw therefore adjusts the angle of the feedthrough housing with respect to the Z-axis stage. Before adjusting the planarity, the four M4 × 45 mm screws holding the bellows flange to the Z-axis stage assembly must be slightly loosened with a 3 mm hex driver. Do not remove these screws. Simply loosen them enough to allow rotation of the feedthrough housing.

While observing the probe through the microscope, use a 4 mm hex driver to turn the differential screw and adjust the angle, as shown at right. Tighten the four M5 × 45 screws and check the angle by making contact to a metallic substrate. Marks made by the probes on the metallization when contact is made can be seen in the microscope image at high magnification. The marks should be uniform. Adjust planarity until these marks are uniform. If the adjustment range is inadequate, the probe must be manually adjusted by loosening the mounting set screws and rotating the probe itself in the probe arm.



Tighten the four M5 × 45 screws. Check the angle once more to be sure the tightening did not change the angle.

Note: the M5 × 45 screws should be installed to a torque of 16 in·oz (11 N·cm). If these screws are overtorqued, the Z-axis stage will bow and the bearings will loosen; a symptom of this problem is play in the Z-axis micrometer. The torque required, 16 in·oz, is much lower than one might think would be needed. We recommend a torque wrench be used to ensure these screws are not over-torqued.

Planarity adjustment should be necessary only once each time a probe is installed. For probes with a single contact, planarity adjustment is not critical; the probe angle can be adjusted to $\pm 5^\circ$.

5.2 Sample Holders

Coax and triax sample holders are available to bias or ground the sample holder. These require the connection of a cable inside the radiation shield to the sample holder, and an additional connector on the bottom of the chamber. Details of the connection are explained in the Operation section.

5.3 Vibration Isolation Equipment

5.3.1 Pump Line Vibration Isolator

The pump line vibration isolator includes a bucket with NW-25 fittings and 1 m stainless steel bellows. The bucket must be filled with 'pre-mix' or 'posthole' concrete to provide the vibration isolation. This requires approximately 90 lb (40 kg) of concrete. Mix the concrete according to directions provided with the concrete, and then fill the bucket with the mixture. After the concrete has cured, turn the bucket handle-side up and place it on the three rubber pads included with the kit. Connect the bucket between the turbo vacuum system and the probe station's vacuum isolation valve as shown below.

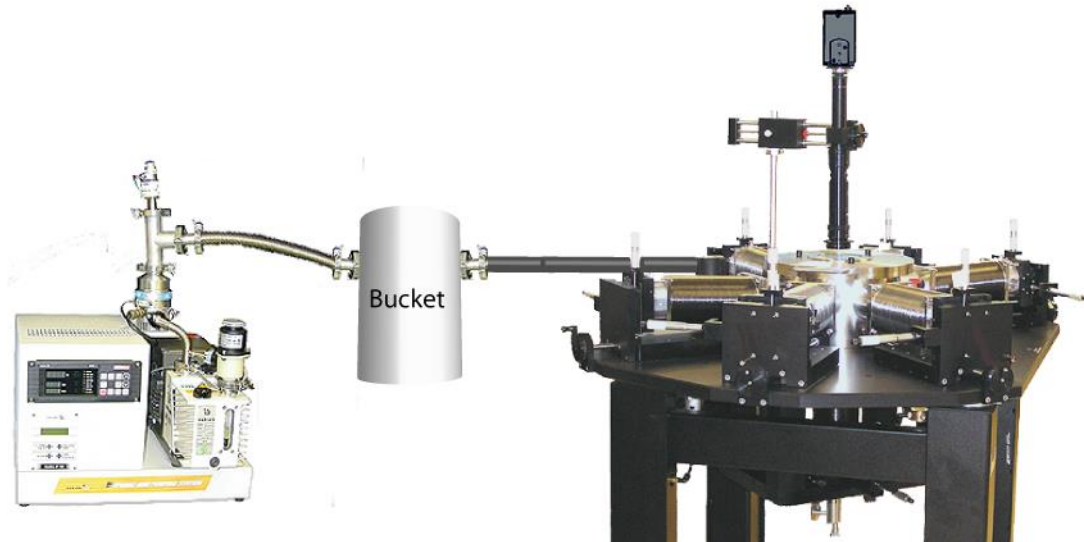

5.4 Chamber Vacuum Level Gauge

The capacitance manometer chamber vacuum level gauge allows the monitoring of the vacuum level in the chamber.

Clamp the gauge to the appropriate chamber port.
Consult the gauge manual for operating instructions.



6. Maintenance

6.1 Cleaning Probe Tips

Probe tips made of beryllium copper (denoted by BeCu in the part number) have a normal shelf-life of about 1 month before they develop an oxide layer which may impede good electrical contact. If you notice discoloration of the tips or a change in electrical properties, locate the chemical kit that came with the probe station and use the Probe Cleaner in the following steps. The tips are very delicate; handle them carefully and do not touch them.

Remove the probe from the system. Place a small drip cup under the probe tip. Wearing impermeable gloves, dispense one full-strength drop of Probe Cleaner just above probe tip letting the cleaner run down the tip and into the drip cup. Do not allow the cleaner to contact any part of the probe body. For heavily oxidized probe tips, repeat as necessary.

Within 30 seconds, follow with three or four drops of de-ionized or distilled water applied in the same manner to rinse the probe tip clean. Then rinse with three or four drops of isopropanol. Allow to dry thoroughly before use.



Do not use Probe Cleaner on stainless steel, chrome, pewter, aluminum, or brass. Avoid spilling on laminates, countertops, Formica, or synthetic surfaces which may be affected; clean spills immediately.

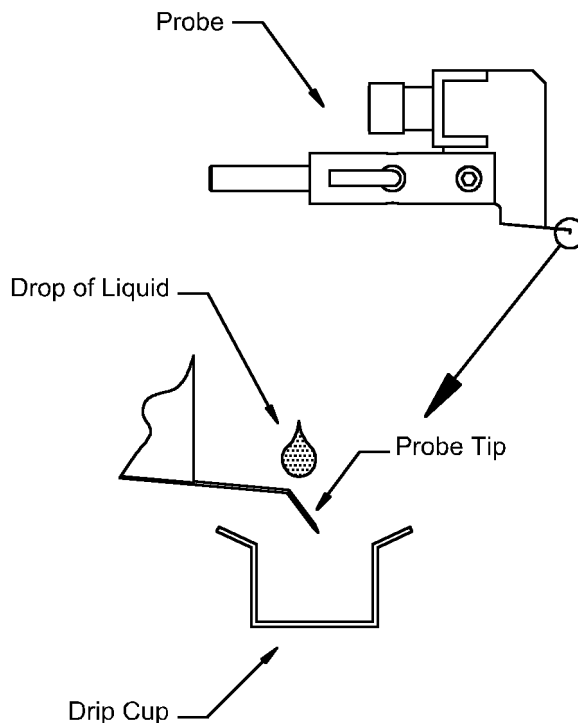

Caution: Probe Cleaner contains thiourea, sulfamic, corrosion inhibitors, and detergent. Avoid contact with skin and eyes. In case of contact, flush immediately and thoroughly with water for 15 minutes. Call a doctor or poison control center for more advice.

Caution: if swallowed, do not induce vomiting. Immediately call a doctor or poison control center. Keep out of the reach of children.

Warning: this product contains thiourea, a chemical known to the state of California to cause cancer.

6.2 Applying Anti-Fog to the Chamber Viewport

The external (upper) surface of the chamber lid can fog when internal temperatures are low. To prevent fogging, locate the chemical kit that came with the probe station and use the Anti-Fog Solution in the following steps.

1. Apply the solution to a small, folded, dry cotton cloth and wipe onto the upper surface of the chamber lid viewport using a circular and overlapping motion. Allow the solution to dry until a slight haze appears.
2. Apply another coat to ensure complete and uniform coverage.
3. Remove the final haze with a clean, dry cotton cloth.

Caution: the Anti-Fog solution is flammable. Keep it away from flame, heat, sparks, and other ignition sources. Store it below 120 °F.



Caution: the solution is an eye irritant. In case of eye contact, remove any contact lenses, flush the eyes with water for 15 minutes, and contact a doctor immediately. Keep out of reach of children.

6.3 Replacing Probe Blades

The alumina probe blade on ZN50 probes may be changed in the event that it has been damaged or if a different tip is desired. Wear gloves while changing blades and avoid touching the electrical conductors on the blade; touching them can reduce their electrical isolation to ground. Place a small cup under the blade to capture any dropped screws or lead beads.

1



Disconnect the SMA connector.

 **Important:** the back of the SMA plug must be held steady while the nut is unscrewed from the probe's SMA jack.

2



Using a 1.5 mm hex driver, loosen the M3 probe arm set screws.

3

Remove the set screws.



Remove the blade.

Rotate the probe to access one of the set screws that fastens the probe blade to the probe. Using a 1.5 mm hex driver, remove the set screw. Rotate the probe to access the set screw on the other side of the blade and remove that screw as well. Discard the set screws. Work the blade back and forth to release and remove it.

4

Between the blade and each set screw are lead beads. The beads cushion the contact between the screws and the blade to help prevent the blade from cracking when the screws are tightened. When the old blade is removed, one or both beads may fall out or drop into the slot for the blade. Any beads obstructing the slot should be pushed out and removed with a small tool such as a 1.5 mm hex driver. Beads that remain in their original positions can be left and used with the new blade.

5

Add a new bead if necessary.



Start the set screw.

Slide the new blade all the way into the probe slot and square its bottom edge with the bottom of the probe body. Hold the new blade in position. If a new bead is needed, place the bead in the screw hole and start the set screw. Turn the probe body over and place a new lead bead (if needed) in the second hole, and start that set screw. Tighten both screws evenly and firmly, keeping the blade all the way back in its slot and squared to the probe body. Occasional checking of the screws for tightness is recommended.

6

Rotate the probe back to the upright position, tighten the set screws holding the probe to the probe arm, and reattach the SMA connector. The back of the SMA plug must be held steady while the nut is screwed onto the probe's SMA jack. Hand tighten until snug.



6.4 Transfer Line and Cryogenic Efficiency

Generally, transfer lines will not need to be serviced for a number of years after delivery. Even if there is a small residual amount of gas (other than helium) in the transfer line vacuum space, it will be cryopumped away once helium transfer has started. (Liquid nitrogen is less effective, and with liquid nitrogen, transfer line vacuum is more critical.)

If the system efficiency drops (cryogen consumption increases), if the transfer line starts to become noticeably cooler during operation, or if the transfer line starts to ‘sweat’ or frost during operation, the transfer line vacuum may have become ‘soft’. Note the bayonet end on the system and the transfer line nearby will sweat and frost during normal operation, especially during cooldown and when the sample temperature is low. The transfer line elsewhere should not sweat, frost, or feel noticeably cool. If the transfer line vacuum is determined or suspected to be ‘soft’, the transfer line should be pumped with a high-vacuum, dry pump, such as a turbomolecular pump. An evacuation adapter (shown at right) is needed for this operation. It is also recommended to have the transfer line leak checked as it is pumped, to eliminate the possibility that a leak is the cause of the poor vacuum. The transfer line should be evacuated for a minimum of 12 hours if it is leak tight and simply being re-evacuated. Initially, it is evacuated for several days, and if the transfer line has been opened or vented, it may need to be pumped again for several days, especially if it has been exposed to damp air.



The evacuation adapter is delivered with the transfer line. If the necessary pumping and leak-checking equipment is not available on site, the transfer line can be sent back to Lake Shore or a local representative for service.

7. Troubleshooting

7.1 The Microscope Will Not Focus

If the microscope will not focus, adjust the height of the microscope using the procedure described in the Assembly section. If the microscope still cannot be focused, vibration from the fan in the light source may be causing the problem. If the light source is on the same table as the TTP, try moving the light source off the table, or placing rubber feet beneath the light source.

7.2 The System Fails to Cool

1. If the foot valve is not fully open when the transfer line is precooled, air can backstream into the line and plug or partially plug the transfer line. This will limit the flow through the line, decreasing cooling power and efficiency, and may cause the transfer line to fail completely to deliver liquid. If this happens, remove the transfer line from the cryogen Dewar, set the foot valve to 6 turns open after the foot valve is no longer frozen, and warm the transfer line back to room temperature. Wait an additional 10 minutes for the inner line to warm and blow dry nitrogen or helium through the line to remove water. Then restart the process of precooling the line.

2. If the transfer line fails to precool properly and the outside of the transfer line is cool or has a cold spot, there may be a problem with the transfer line. If the line is generally cool, the vacuum inside the transfer line may be inadequate. If there is a cold spot on the transfer line, there may be a physical touch between the inner line and the outer vacuum jacket of the transfer line. If either condition exists, please contact Lake Shore or your local representative.

7.3 Loss of Continuity between the Signal Connector and the Blade

A loss of continuity is usually due to a broken center conductor in the cable, often caused when the back of the SMA plug on a ZN50 probe is not held steady when the probe is installed. Check the continuity of the center conductor by measuring the resistance between the center pin of the signal connector and the center of the SMA connector. If the resistance is not approximately zero, the cable must be replaced. The procedure to replace the cable is described in the Configuration Changes section.

7.4 Insufficient Sample Illumination

If the illumination is insufficient even when the light source is turned all the way up (50 to 70% is the typical maximum required), remove the fiber optic bundle from the light source and check that the bulb is centered in the opening. See the light source manual for further information.

Appendix 1. Temperature Control Connection and Electrical Pinouts

The following tables show the standard pinouts for the temperature control and readout cables of the system. As originally configured, the cables are designed to ground the chamber, which forms an electrical Faraday cage around the sample, to the chassis of the controller. Independent of the provided cabling arrangement, there should always be precisely one ground connection. In many experimental arrangements, however, the chamber may optimally be connected to a different ground. In this case, it is best to disconnect the ground connection to the controller chassis in order to avoid multiple and potentially conflicting grounds. The best way to disconnect the ground to the controller chassis is to unplug or cut the round, green ground connector (banana type) on the temperature control cable.

The 19-pin feedthrough used to read and control the cold head thermometer and heater and the radiation shield thermometer and heater is wired as shown in the table below. **Note:** cabling and shielding are for the Lake Shore Model 340 temperature controller configuration.

19-pin Connector

Function	Wire ¹	Pair ²	19-Pin ³	Cable, Pair, Color ⁴	Connector ⁵
Cold Head SD V + ⁶	PB-36 ⁸	1	A	1, 1, red	DIN, 4
Cold Head SD V –	PB-36	1	B	1, 1, black	DIN, 2
Cold Head SD I +	PB-36	2	C	1, 2, white	DIN, 5
Cold Head SD I –	PB-36	2	D	1, 2, green	DIN, 1
Cable Shield	None	None	None	1, none, shield	DIN, 3 ¹⁰
Cold Head Heater + ⁷	(2) × PB-32 ₉	3, 4	E	2, 1, red	Banana +
Cold Head Heater –	(2) × PB-32	3, 4	F	2, 1, black	Banana –
Cable Shield and Chamber Ground	None	None	Connector body	2, none, shield	Single banana ¹¹

Rad Shield SD V+	PB-36	Ribbon cable (5)	N	3, 1, red	DIN, 4
Rad Shield SD V–	PB-36	Ribbon cable (5)	P	3, 1, black	DIN, 2
Rad Shield SD I +	PB-36	Ribbon cable (6)	R	3, 2, white	DIN, 5
Rad Shield SD I –	PB-36	Ribbon cable (6)	S	3, 2, green	DIN, 1
Cable Shield	None	None	None	3, none, shield	DIN, 3
Rad Shield Heater + ¹²	CU-32 ¹³	7	T	4,1, red	Banana + ¹⁴
Rad Shield Heater –	CU-32	7	U	4, 1, black	Banana – ¹⁴
Cable Shield	None	None	Connector body	4, none, shield	None

Notes:

¹ Wire type and size used inside chamber

² Twisted pair number inside chamber

³ Letter designator on feedthrough and mating cable connector

⁴ In cable to temperature controller

⁵ On controller end of cable

⁶ SD is silicon diode thermometer.

⁷ Cold head heater is 50 Ω , 50 W at 50 V maximum.

⁸ PB-36 is 36 AWG (0.125 mm) phosphor-bronze, heavy polyimide (HML) insulated.

⁹ PB-32 is 32 AWG (0.200 mm) phosphor-bronze, heavy polyimide (HML) insulated.

¹⁰ Shield wire connected to pin 3 of controller

¹¹ Ground wire connected to single banana, which plugs into chassis next to heater output of temperature controller. The other end of the ground wire is connected to the body of the 19-pin mating connector. This connects the probe station chamber to the chassis ground of the controller. See the discussion above to determine if this connection should be left in place or broken.

¹² Optional radiation shield heater is 25 Ω , 100 W at 50 V maximum.

¹³ CU-32 is 32 AWG (0.200 mm) copper.

¹⁴ Dual banana to analog-programmable power supply for radiation shield heater.

The 6-pin feedthrough used to read the probe arm thermometer (and optionally power the probe arm heater) is wired as shown in the table below.

6-pin Connector

Function	Wire ¹	Pair ²	6-Pin ³	Cable, Pair, Color ⁴	Connector ⁵
PT V + ⁶	PB-36 ⁷	1	A	1, 1, red	DIN, 4
PT V –	PB-36	1	B	1, 1, black	DIN, 2
PT I +	PB-36	2	C	1, 2, white	DIN, 5
PT I –	PB-36	2	D	1, 2, green	DIN, 1
Cable Shield	None	None	None	1, none, shield	DIN, 3 ⁸

Notes:

¹ Wire type and size used

² Twisted pair number inside stage bellows

³ Letter designator on 6-pin feedthrough and mating cable connector

⁴ In cable to temperature controller

⁵ On controller end of cable

⁶ PT is platinum thermometer

⁷ PB-36 is 36 AWG (0.125 mm) phosphor-bronze, heavy polyimide (HML) insulated.

⁸ Shield wire connected to pin 3 of controller.

Appendix 2. Low Current Measurements and Triax Configuration

This appendix contains information relevant to electrical transport measurements on high-impedance devices or, more generally, devices that cannot be characterized if there is significant current leakage in the measurement system. Typical devices for which this may be relevant include nanoscale quantum devices and most semiconductors at low temperatures.

Note that in the figures, the term ‘cryostat’ refers to the refrigerator/chamber assembly, and a ‘chuck’ is a sample holder.

Most electrical transport measurements can be looked at as a measurement of current. Suppose it is necessary to measure precisely a resistor with resistance of the order of $10^{15} \Omega$, and a voltage of 10 V is applied to the resistor. In principle, a current of 10^{-14} A (10 fA) will flow through the ammeter. The problem is there may be more paths for the current to flow than just through the unknown resistor.

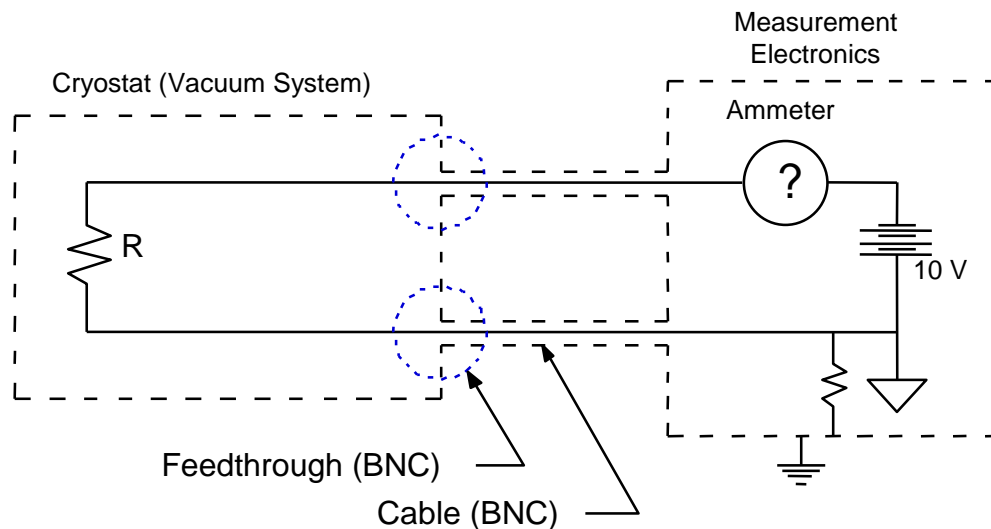

Figure 1. Simple circuit to measure resistance.

These additional paths allow current to ‘leak’ through the circuit, and more current is measured than just that which flows through the unknown resistor. In cryogenic systems, typical leakage paths can occur at feedthroughs and connectors (especially if the humidity is high!), through insulation of the wiring at places where the wire must be supported or thermally anchored. Even for clean and dry connections (for example at a feedthrough), requiring that leakage current is no more than 10^{-12} A/V is challenging. In this case, the leakage resistance is specified to be greater than $10^{12} \Omega$. Incorporated into the circuit in Figure 1, the leakage resistance would effectively short out the unknown resistor, and the measurement of the unknown resistor would have an error of approximately a factor of 1000.

The circuit in Figure 1 is not without some useful features. Both the unknown resistor and the measurement system are surrounded by a grounded metallic enclosure that shorts away any capacitively coupled noise to ground. The wiring between enclosures is also surrounded by shields, and the shields connect to the enclosures at coaxial connections. The whole measurement is effectively inside a Faraday cage. For the wiring, the typical connector is a BNC. At the electronics module, there might typically be two panel-mount BNCs, the wiring would be BNC cables, and at the cryostat, there

would be hermetically-sealed BNC feedthroughs, sketched in Figure 2. In the above circuit, it is wrong to expect the ground to be exactly at perfect ground potential. No two grounds are really at exactly the same potential, and grounds can have any amount of noise, depending on their environment and how carefully they are configured. Ground loops, for example, can make grounds very noisy. In the circuit in Figure 1, it might help to isolate the shield at one of the BNC connections. It might also help if the cables were twisted together to minimize inductive coupling of noise from the environment. No matter what precautions are taken, however, the shields will have some noise, and this noise will couple capacitively to the signal wires, contributing to the current noise in the measurement.

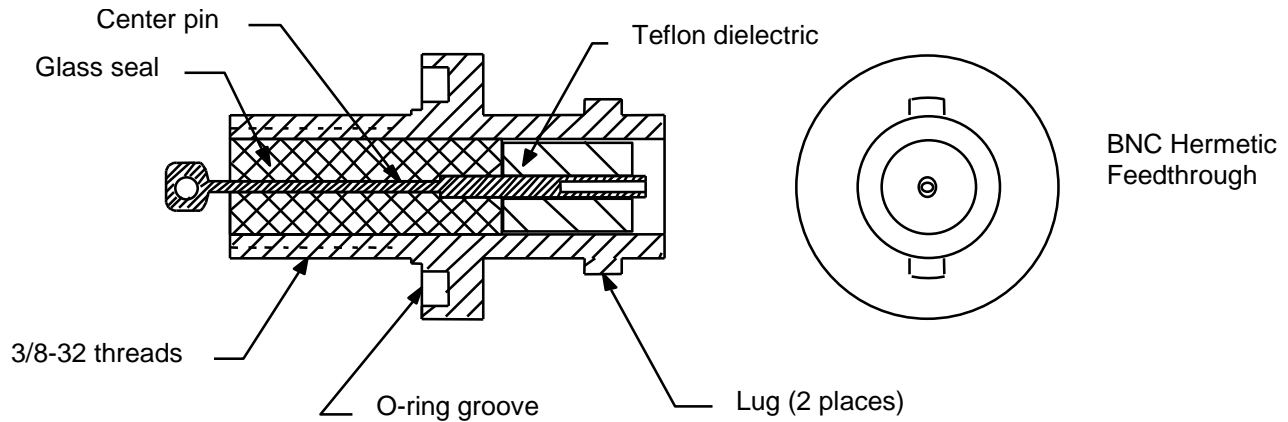

Figure 2. Typical BNC hermetic feedthrough

In the circuit in Figure 1, the reason the leakage resistance shorts out the unknown resistor is all the wiring is surrounded by the same potential, which is that of the Faraday cage. Suppose, instead, the upper wire were to be insulated and surrounded by a ‘guard’ of conductor held at 10 V, and the lower wire were to be insulated and surrounded by a guard of conductor held at ground potential. Suppose even the feedthroughs continued this guard; then even if the leakage resistance between the upper wire and its guard were the same $10^{12} \Omega$ as above, no leakage current would result because both the wire and the guard are at the same potential. This is sketched in Figure 3.

If, in the circuit in Figure 3, the ‘ammeter’ is perfect, as are the circuits that drive the guards at the same potential as the signal wires inside them, the measurement will have no error. In practice, the guard drive circuits are not perfect, and the guard potential is offset from the signal potential by some small amount. Suppose this is 0.1 mV, and the leakage resistance between signal and guard is $10^{12} \Omega$. Then the leakage current is 10^{-16} A . The current through the unknown ($10^{15} \Omega$) resistor is 10^{-14} A , so the measurement error is 1%. For such a large resistance this is good. It represents an improvement of a factor of 10^5 over the first circuit. The second circuit is superior also in its noise performance. Noise in the ground potential does not capacitively couple to the signal, but instead couples to the guard. The guard is driven to have the same potential as the signal, and the noise coupled from the ground to the guard is reduced dramatically by the drive circuit before it can couple to the signal.

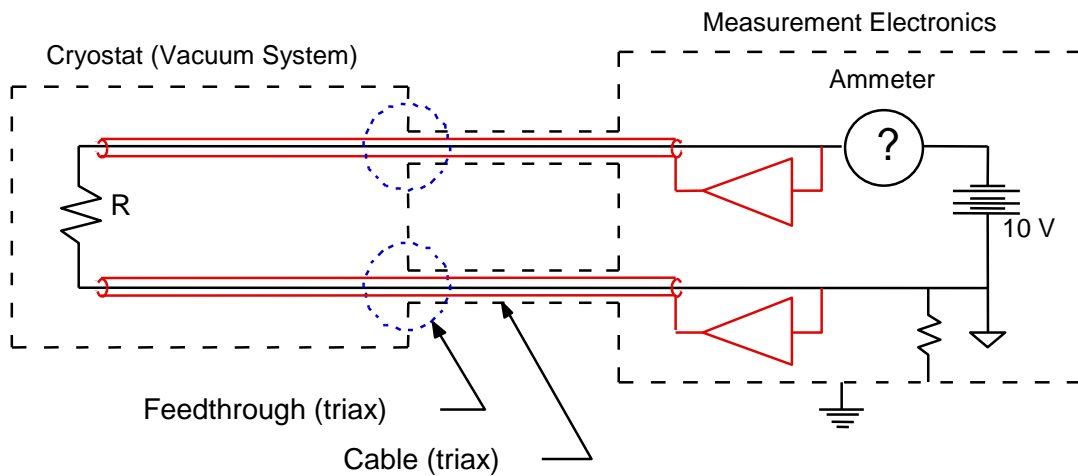

Figure 3. Improved circuit for measuring high-resistance devices.

In the circuit in Figure 3, the hermetic feedthroughs at the cryostat vacuum interface are called triaxial feedthroughs, sketched in Figure 4. Note the three small posts labeled lugs in the sketch. Triaxial connections are made in a bayonet style, typically with three lugs and three slots. The 3-lug triax is mechanically stable and therefore contributes little noise to the measurement. Originally, triax were produced with only two lugs (like BNC's), and the connection could rock, contributing some noise to the measurement. It is important to keep track of which style triax is used on the measurement electronics, cables, and cryostat, to ensure compatibility. Desert Cryogenics uses 3-lug triax on all cryostats and cryogenic/vacuum systems unless otherwise requested.

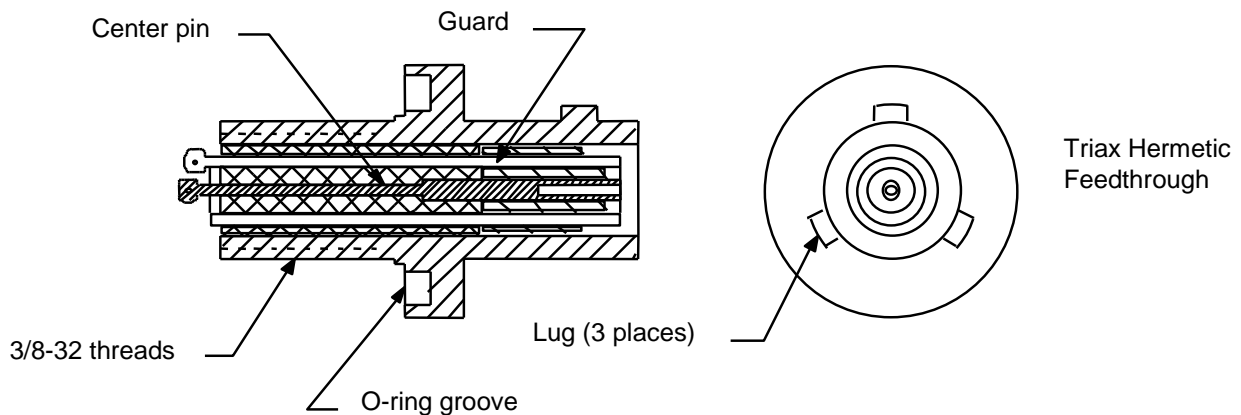

Figure 4. Typical triax hermetic feedthrough

In probe systems, the unknown 'resistor' is typically a device on a wafer. The wafer is held down to a sample holder. The back side of the wafer may not be relevant to the measurement, may need to be isolated from the sample holder, may need to be held at a given potential, or may even need to be held at a given potential while measuring the current through the back side. In the first case, the sample holder may be made of solid copper or other metal. In the second case, the top of the sample holder must be made of an insulating material such as sapphire.

In the case of a device for which a backside contact is necessary, the sample holder must have a conducting top surface, and this surface must be isolated from ground. This is shown schematically in Figure 5.

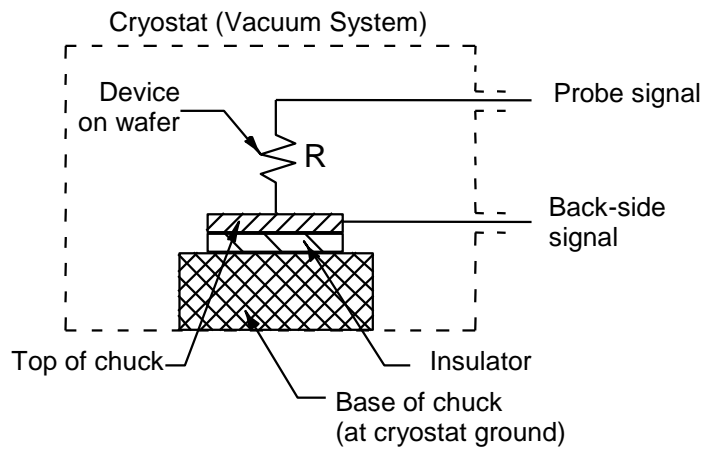

Figure 5. Device on sample holder with backside contact.

In Figure 5 the device is simple and has only a single probe contact. Most real devices have multiple contacts and require multiple probes. The probes can be configured as coaxial or triaxial. Here the focus is on the backside contact. The backside signal is fed through the vacuum wall coaxially. It, too, could be fed triaxially, with the guard floating, extending nearly to the backside contact. That will eliminate leakage in the wiring to the backside contact. However, if the backside contact is critical, the above sample holder does provide a leakage path between the device and the cryostat ground. This can be eliminated by adding a guard to the sample holder, shown schematically in Figure 6.

The sample holder in Figure 6 is often called a triaxial sample holder, since it eliminates leakage in the same way that a guarded triaxial cable or feedthrough does. Similarly, the sample holder in Figure 5 is often called a coaxial sample holder. For measurements that are performed only at cryogenic temperatures, the leakage through a coaxial sample holder is likely to be extremely small (insulators improve dramatically with reduced temperature). However, the other parameter of importance is the capacitance to the cryostat ground. For measurements that are extremely sensitive to noise, the guard eliminates any direct capacitance to the cryostat ground. Sample holders are typically characterized by their leakage resistance between top surface and guard, the leakage resistance between guard and ground, the capacitance between top surface and guard, and the capacitance between guard and ground.

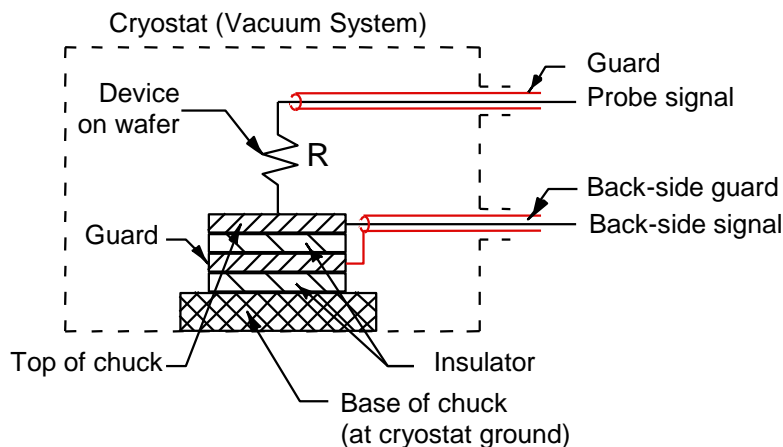

Figure 6. Device on sample holder with guard and backside contact.

Seven sample holders are offered for Desert Cryogenics' probe station systems: grounded, isolated, coaxial, and triaxial sample holders for 26 mm square samples; and grounded, coaxial, and triaxial sample holders for 2-inch diameter samples. For full 2-inch diameter samples, the top surface of the sample holder must have thermal contraction matching that of the wafer in order to minimize the chance of damage to the wafer on cooling. This is less critical on the smaller sample holders for smaller samples.

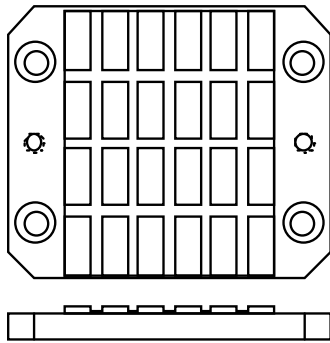

Figure 7. TT-CS-G sample holder.

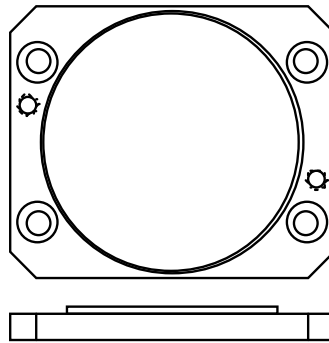

Figure 8. TT-CS-I sample holder with sapphire isolation.

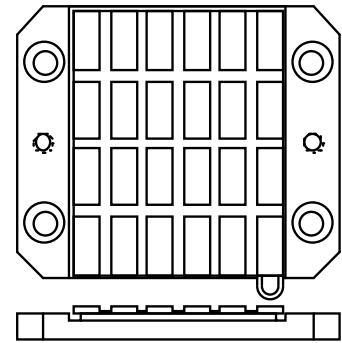

Figure 9. TT-CS-C and TT-CS-T sample holders. Contacts are provided in the lower right corner.

Figures 7–11 show the available sample holder for the probe station systems. The coaxial and triaxial sample holders look very similar to each other (the layers of isolation and guard are thin). In Figures 10–11, the top of the sample holder is made of a conducting gold-plated material designed to match the contraction of typical wafer material, such as silicon or sapphire. With the exception of the TT-CS-G, which allows temperatures to 475 K (202 °C), all sample holders are limited to 400 K (127 °C). The CS sample holders are designed for holding chips up to 26 mm square. The C2 sample holders are designed for holding full 2-inch wafers. (The XY probe travel of the probe station is 52 mm × 26 mm.) All leakage resistances of coaxial and triaxial sample holders are greater than 30 GΩ. Capacitances for CS sample holders are <100 pF. Capacitances for C2 sample holders are <150 pF. If only small samples are to be measured, the CS sample holders will perform better and more economically. If no backside measurement is needed, the isolated sample holder should be considered. For measurements where the backside potential is irrelevant, a grounded sample holder should be considered.

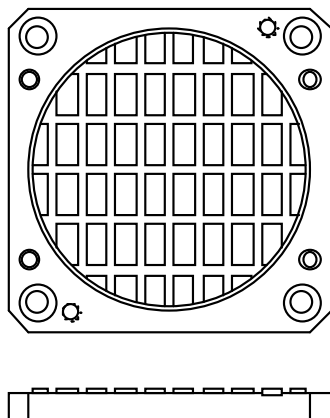

Figure 10. TT-C2-G sample holder for 2-inch wafers at temperatures up to 400 K.

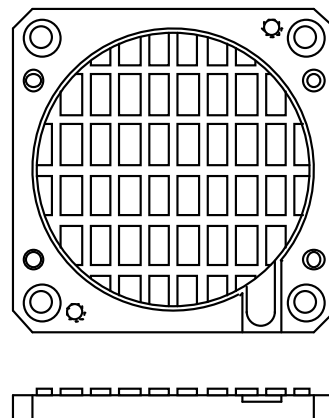

Figure 11. TT-C2-C and TT-C2-T sample holders. Contacts are provided in the lower right corner.

With the Desert Cryogenics probe station system, measurement of high-impedance devices can be achieved with superior performance. For example, with a guard which is matched to the signal to within 0.1 mV, leakage current is less than 3.3×10^{-15} A. With a 33 V bias on a $10^{14} \Omega$ device, measurement error is under 1%. This is true for both triaxial probe measurements, and for the backside contact on our triaxial sample holders. With specially selected probes and sample holders, this performance can be improved on request. Performance is typically improved at low temperatures. Sample holders for larger full wafers are available for larger probe systems. Sample holders for use at temperatures up to 475 K in probe station systems may also be available on request.